

# SCIENTIFIC AMERICAN

[Entered at the Post Office of New York, N. Y., as Second Class Matter. Copyright, 1902, by Munn & Co.]

Vol. LXXXVII.—No. 14.  
ESTABLISHED 1845.

NEW YORK, OCTOBER 4, 1902.

[\$3.00 A YEAR.  
8 CENTS A COPY]

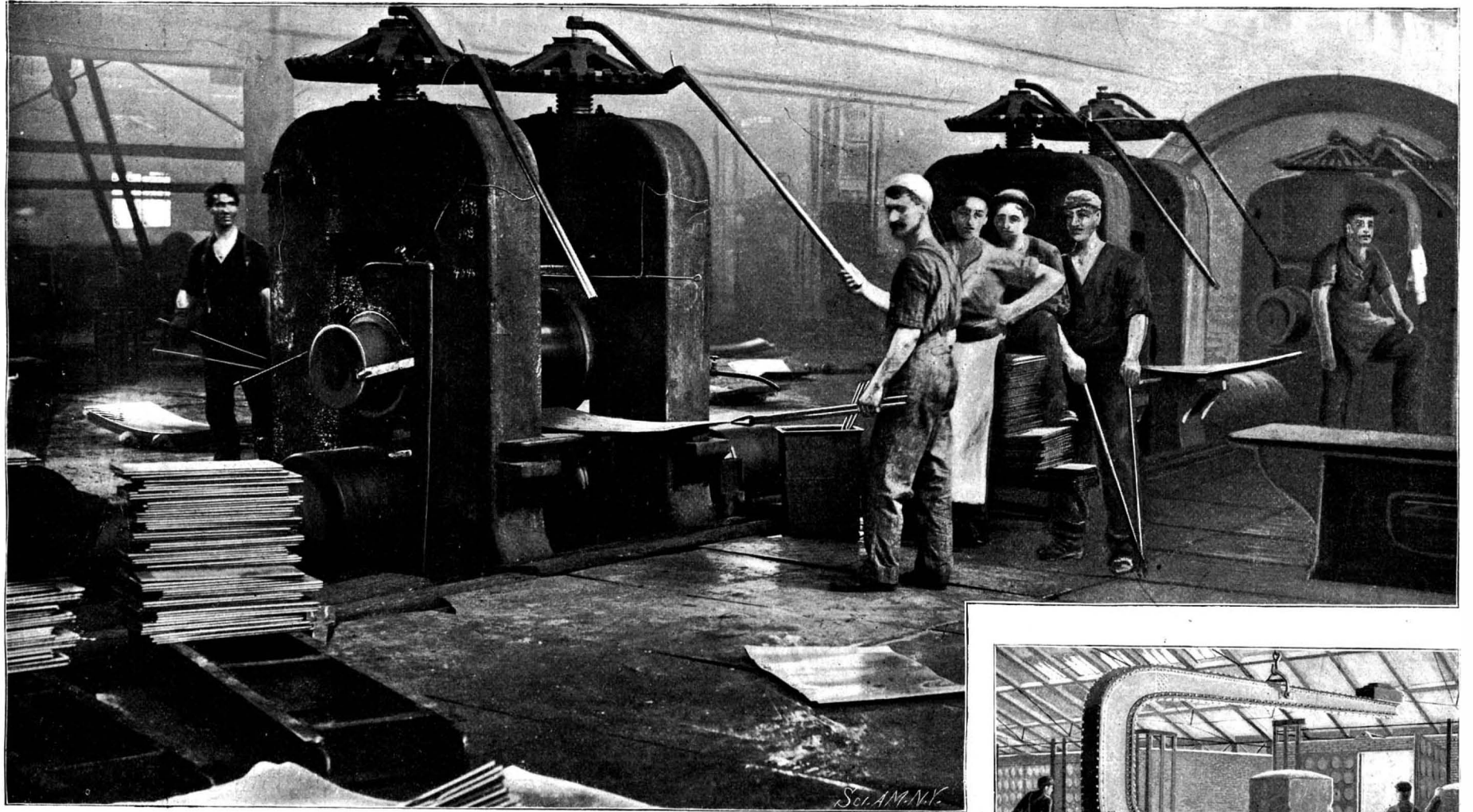

Rolling Mill in Which Plates are Rolled into Sheets.

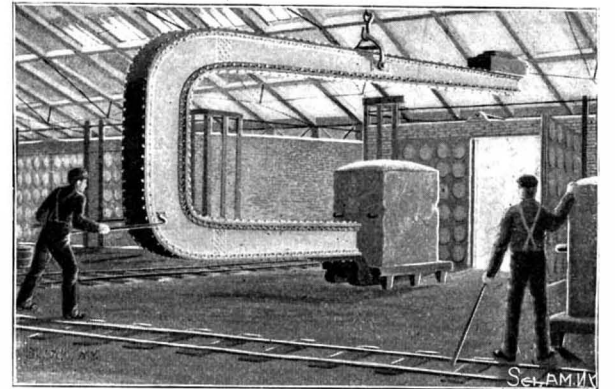

Charging Machine for Placing Annealing Pots in Furnace.

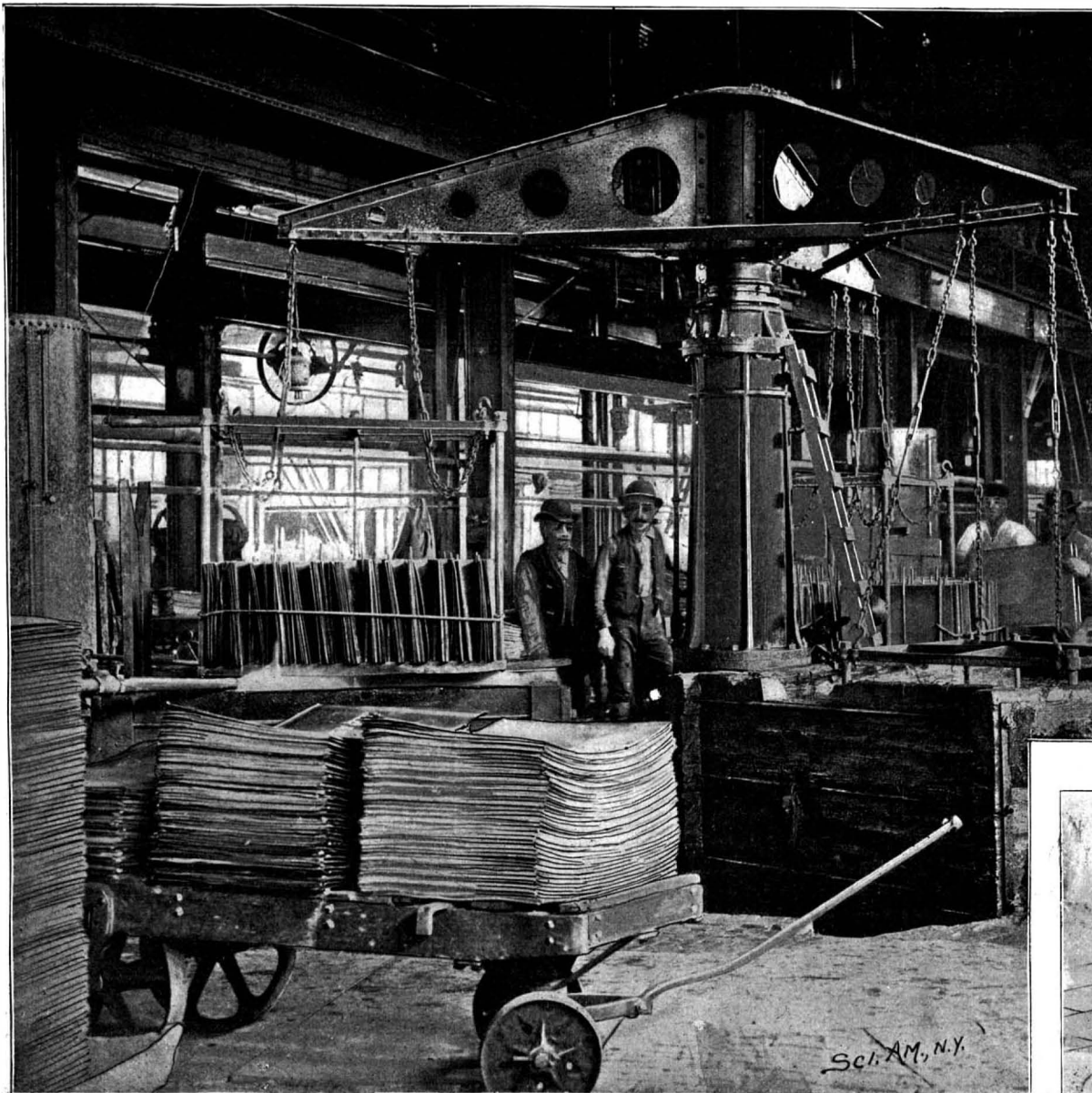

The Pickling Machines for Cleaning Plates Preparatory to Tinning.

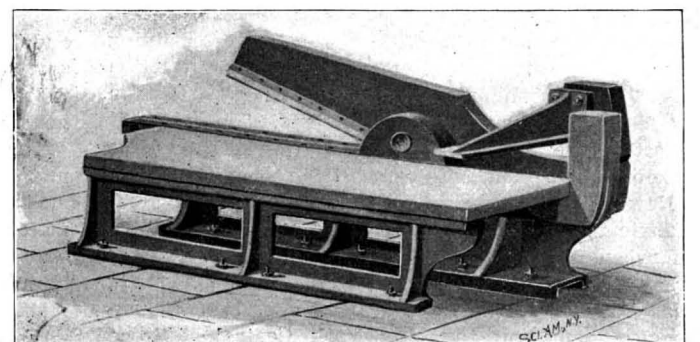

Doubling Shears in Which Plates are Folded.

THE MANUFACTURE OF TIN PLATE.—I.—[See page 221.]

## SCIENTIFIC AMERICAN

ESTABLISHED 1845

MUNN & CO., - - Editors and Proprietors

Published Weekly at

No. 361 Broadway, New York

### TERMS TO SUBSCRIBERS

One copy, one year for the United States, Canada, or Mexico ..... \$3.00  
One copy, one year, to any foreign country, postage prepaid, £0 16s. 5d. 4.00

### THE SCIENTIFIC AMERICAN PUBLICATIONS.

Scientific American (Established 1845).....\$3.00 a year  
Scientific American Supplement (Established 1876)..... 5.00 ..  
Scientific American Building Monthly (Established 1885)..... 5.00 ..  
Scientific American Export Edition (Established 1878)..... 5.00 ..  
The combined subscription rates and rates to foreign countries will be furnished upon application.  
Remit by postal or express money order, or by bank draft or check.  
MUNN & CO., 361 Broadway, New York.

NEW YORK, SATURDAY, OCTOBER 4, 1902.

The Editor is always glad to receive for examination illustrated articles on subjects of timely interest. If the photographs are sharp, the articles short, and the facts authentic, the contributions will receive special attention. Accepted articles will be paid for at regular space rates.

### FUEL OIL IN THE MERCHANT MARINE.

Valuable information regarding the use of fuel oil on merchant steamships is contained in a report made by Lieut. Winchel on an investigation which he was ordered to make for the Navy Department of the efficiency of the oil-fuel plant fitted on the steamship "Mariposa" of the Oceanic Steamship Company of San Francisco, which trades between San Francisco and Tahiti. The "Mariposa" is a vessel of 3,160 tons. Her average indicated horse power, as shown on the trip under investigation, was about 2,491, and the mean speed was 13.53 knots an hour. The consumption of oil was 278 barrels per day, the average consumption of oil being 3,720 pounds per hour, which works out as 1½ pounds of oil per horse power per hour. Although in some of the most carefully designed and operated plants on shore, engines have been operated at as low a rate as 1½ pounds of coal per horse power hour, the consumption is practically 50 per cent less in weight of fuel than would be required with triple-expansion engines of the type installed on the "Mariposa" if coal were being used. In addition to the saving in dead weight carried, there was a great economy in the working force required, the engine and boiler room staff being reduced from 36 to 20 men. The boilers of the "Mariposa" contain altogether eighteen furnaces, and of these only twelve were used. There are two burners to each furnace; but it was only for short periods of time, when the engines were run at full power, that all the burners were in use.

The economy in fuel realized in these trials is not so marked as the economy in labor; for even on a vessel run under such high pressure as the "Deutschland" of the Hamburg-American Line, which has crossed the Atlantic at an average speed of 23.5 knots an hour, the consumption of ordinary steam coal is only 1½ pounds per horse power per hour, including auxiliaries; and on the vessels of the Inch Line, trading on the east coast of England, which use every refinement in the way of economizers, superheaters, etc., a consumption of a fraction under one pound of coal per hour has been realized. But it is in the economy of labor and space, and in the convenience of stowage, that oil fuel will have its greatest attraction for shipowners. Great as are these advantages for the merchant service, they are even more valuable for the navy, since the decrease in weight and bulk of fuel, and the possibility of stowing it in the double bottom, will place practically all of the space now used for bunkers at the service of the naval architect. Moreover, the diminished number of the crew will mean diminished requirements of weight and space for their accommodation. The saving thus effected can be given to an increase of armor or guns, or engine power, according as the architect wishes to develop either of these features in his vessel.

### IMPORTANT SPEED TESTS OF STEAM AND ELECTRIC TRAINS.

The most direct evidence thus far afforded that the New York Central Railroad is taking active steps toward the installation of electric traction for its suburban service in this city, is a series of tests which have recently been carried out on the experimental track of the General Electric Company at Schenectady. These tests were made with a view to determining the relative efficiency of steam and electric traction in such suburban passenger service as is carried on by the New York Central Company. The primary object of the test was to make a comparison of the rate of acceleration of the same train when hauled by a New York Central suburban engine and by a pair of electric motor cars, such as would be used were the suburban lines to be equipped with third-rail electric traction. For the purpose of the test, a train of six cars was made up, which included five standard passenger coaches of the New York Central Railroad preceded by a dynamometer car. The engine selected was one of the big tank engines especially designed

for the suburban service of the New York Central Railroad, the engine being provided for this purpose with large heating surface and cylinder capacity and small-diameter six-coupled drivers. These engines have a total weight of 214,000 pounds, of which 128,000 pounds is on the drivers; a total heating surface of 24,065 square feet; cylinders 20 x 24 inches; a boiler pressure of 200 pounds to the square inch and a tractive power of 25,900 pounds. They have proved very successful, the acceleration being unusually rapid. Indeed, for this class of work, where stops are frequent, they are probably the best engines of their kind in this country to-day, and hence admirably adapted for a comparative test of capacity of acceleration with electric motor cars. For the electric test two General Electric motor cars, one weighing 73,000 pounds and the other 70,000 pounds, were used. These cars are 54 feet over all in length, and are equipped with four "G E 55" motors, all axles being provided with motors and the two cars together giving about the same weight on drivers as the steam locomotive. The test was, therefore, perfectly fair, the acceleration being directly comparable for trains of equal weight. The drawbar pull, speed and time were recorded by the same dynamometer car in all cases, the engine simply being unhitched and the two motor cars coupled up for the alternate trials. In carrying out the tests, the train of six cars with its engine or its electric motors, as the case might be, was started from rest and run over one mile of track, the acceleration being made as rapidly as possible with the power available. These runs were repeated, dropping off one car at a time, and a careful record was kept of the speed attained in 10 seconds, 20 seconds, 30 seconds, etc. The New York Central coaches weighed each from 48,200 pounds to 60,250 pounds, and the total weight of the train behind the engine or electric cars varied from 157 tons down to 23 tons.

The full data of this most valuable experiment were given in a paper by E. J. Arnold and W. B. Potter, at the last annual convention of the American Institute of Electrical Engineers, the complete text of which will be found in the current issue of the SUPPLEMENT. The electric runs were made upon the General Electric Company's experimental track against a head wind of 15 miles an hour. In the middle of the run there was a 6½ degree curve, the frictional effect of which was assumed as equivalent to the 1-10 per cent upgrade of the steam runs, which were made on the New York Central main line adjoining the electric works. In the case of the steam runs there was also a head wind of 15 miles per hour. Although the locomotive was especially built for rapid acceleration, having a large firebox and heating surface, the pressure dropped from 200 pounds at the commencement of the mile to less than 185 pounds during the early part of the acceleration. In starting, the throttle was opened wide and steam was used for the full stroke, the engine being hocked up as acceleration proceeded. In neither case was there any slipping of the driving wheels. Although the steam locomotive was able to exert a tractive effort at starting equal to that obtained by the electric motor cars, this high tractive effort was not maintained, but fell immediately with the increase of speed, in spite of the most expert handling of the throttle and reversing lever. The accelerations attained in each case at the end of each 10 seconds were as follows: With a train of six cars, the acceleration at the end of ten seconds was, for the locomotive, 19.5 miles per hour; for the motor cars, 11.2 miles an hour; at the end of twenty seconds, the speed had risen to 16.3 miles per hour for the locomotive and 21.2 miles per hour for the motor cars, the respective figures at the end of thirty seconds being 20.8 miles an hour for the locomotive and 28.1 miles per hour for the motor cars. With four cars only in the train the accelerations were in ten seconds for the locomotive, 12 miles per hour; for the motor cars, 14.4 miles per hour; in twenty seconds, for the locomotive, 19.5 miles per hour; for the motor cars, 27.4 miles per hour; while in thirty seconds the acceleration was, for the locomotive, 24.7 miles per hour, and for the motor cars, 32.4 miles per hour. With only one car attached, the accelerations were in ten seconds for the locomotive, 14 miles per hour; for the motor cars, 22.5 miles per hour; in twenty seconds, for the locomotive, 25 miles per hour, and for the motor cars, 34 miles per hour. In thirty seconds the acceleration for the locomotive was 31.7 miles per hour, and for the motor cars, 38.2 miles per hour.

The comparison of results proves that the electric motors can better utilize the weight upon their drivers during acceleration than a steam locomotive, the motor covering the same distance in the same time with less energy expended and at less maximum speed than a steam locomotive, owing to its being able to maintain its maximum accelerating rate for a longer period. In making the tests the power was kept on until the three-quarter-mile post was reached, when it was shut off and the brakes were applied so as to

bring the train to rest as near the mile post as practicable. The steam train ran from 5 to 15 per cent over a mile before the train was brought to rest, and the electric train from 2 to 4 per cent; but, in spite of the longer distance covered, the average speed of the steam runs only approached that attained in the electrical runs over a shorter distance. Since the electrical runs all show a lower maximum speed and a higher average speed than those made with the steam locomotive, the energy consumption of the electric runs should, therefore, be less for the same work done than with the steam locomotive. Since the motors of electric trains may be placed upon the trucks of ordinary passenger coaches, there is a saving of weight due to the elimination of the locomotive and tender, and the authors of the paper point out that, hence, the true basis of comparison between steam and electrically propelled trains should be the energy per seat mile rather than per ton mile. As an illustration of the advantages, in point of economy of power, of electrical traction over steam, a table based upon these tests is given in the paper, showing the energy required per passenger for both steam and electric runs; and from this we find that for a train of six cars the watt hours per passenger required in a steam train are 43.9, as against 29.7 in an electric train. In a three-car train the watt hours for steam would be 77.4, as against 37.5 for electricity. In a comparison of coal consumption, based upon the actual service of a steam locomotive for twenty-four hours covering four trips between North White Plains and the Grand Central Station on the New York Central road, it was found that the coal consumed per effective horse power hour was 15.6 pounds. In comparing this with electrical traction, it is assumed that the ratio of effective horse power output of motors to the indicated horse power of the central station engine is about 50 per cent. The average coal consumption per horse power hour at the electric power stations is assumed at 2½ pounds, and at this figure the coal per effective horse power output at the electric motors would be 5 pounds. Assuming the head air resistance as 10 per cent and the increased weight of the cars due to their electrical equipment as 20 per cent, the actual comparison of coal consumption works out in the ratio of 6.6 pounds per horse power hour for electric traction and 15.6 pounds for steam traction. Assuming the cost of coal for electrical power is about a third the total cost of that power if maintenance and interest on investment be included, it is concluded that the actual gross cost of electrical power would closely approximate the coal consumption cost of the steam locomotive in this class of service, the maintenance and attendance cost of the electrical equipment being, however, considerably in favor of electrical power.

### THE COLLAPSE OF THE CAMPANILE—THE CAUSE.

In the October issue of the Building Monthly of the SCIENTIFIC AMERICAN will be found an article from the pen of an American, resident in Venice, on the fall of the famous Campanile. Accounts of official neglect have found a place in the daily papers; but it is doubtful if many suspected how culpable the authorities of Venice have been. Commendatore Giacomo Boni, known the world over for his work in the Roman Forum, furnished the writer of the article in question with a mass of information which shows how keenly alive certain architects were to the critical condition of the tower, and how willfully indifferent Italian officials apparently were to the fate of one of their grandest architectural structures.

As far back as 1878 the Italian architect Luigi Vendrasco foresaw the collapse of the old bell-tower and persistently tried to prevent it. His endeavors to save the Campanile ruined his career. It was while directing some work in the palace of the Doges that Vendrasco discovered how great the danger was. Although the fate of the Campanile was no official concern of his, yet he felt it his duty to warn the Syndic, the Prefect, and the various commissions charged with the preservation of architectural relics. Vendrasco's reports were never opened. He appealed to Queen Margherita and even to Queen Victoria. For that last bit of pertinacity he was officially requested to remember that he was an Italian and not an Englishman. Although repeatedly snubbed, Vendrasco still persisted in calling to the attention of the authorities the imminent ruin of the tower. In order to put an end to his letters, the troublesome architect was transferred to Cagliari. His advanced years prevented him from reporting in time to resume his new duties, for which failure he was dismissed.

Day by day Vendrasco saw the disaster approaching. When a cut was made in the east wall of the Campanile in repairing the roof of the Loggetta, Vendrasco saw that a fatal injury had been done. The cut reopened the old fissure of 1745, caused by lightning. Even some of the official engineers and architects now began to show concern; yet so general was the indifference of the Venetians that no steps were



taken to avert a catastrophe. On the very day that the Campanile fell, the unheeded Vendrasco wrote, "The Campanile has but a few hours to stand." Hardly was the ink dry on his paper when the tower fell, crushing in the north end of the Library, almost miraculously sparing the great church and the neighboring magnificent structures that constitute the glory of Venice.

The causes of the collapse of the Campanile are fully discussed in the Building Monthly's article. The fissure opened by the stroke of lightning in 1745 was but indifferently repaired. Telluric movements and electric discharges continually disturbed the injured section. Still another element of weakness was the complete deterioration of the mortar which held the masonry together. Much of this mortar had so far crumbled away as to appear in the ruins like a fine white powder or dust. It had long lost all power of cohesion. Although the mortar had crumbled and become worthless, the bricks in the main were in good condition and showed astonishing hardness. Many were very old, far antedating the building of the Campanile itself. One bore an imperial stamp of the reign of Antoninus Pius; others showed prints of the feet of domestic animals and fowls that had walked upon them before they were burnt. The bricks ranged in age from the first century B. C. to mediæval times. The older ones had been taken from Roman edifices at Aguleia.

Though doomed largely through early official neglect of warnings received, the immediate causes of the collapse of the giant tower were the bungling repairs of the roof of the Loggetta. Here it was that the deep cut previously referred to was made into the base of the part of modern construction. The old fissure reopened, the crevice spreading with alarming rapidity. Even though this condition of affairs was brought to the notice of the city authorities, several days elapsed before concern was shown; visitors were even permitted to ascend to the belfry before steps were taken to preserve the structure. No adequate protection was given to the public on the Piazza up to within half an hour before the crash. One official ascended the belfry five hours before the downfall, and workmen, scaling a ladder resting against the tower-wall, saw the yawning gap spread over the wall ere they fled. A few moments later all that was left of the Campanile was a mass of ruins where the ladder had stood.

A new Campanile will take the place of the old on the Piazza San Marco. Subscriptions are pouring in from all parts of the world. Commendatore Boni declares that work on the new structure will be commenced in the spring. That the new bell tower will not have the same associations with the historic past of Venice goes almost without saying. No traditions will lend their glamor to the modern structure; nor will the old poetic atmosphere cling to the new Loggetta which is to take the place of the ruined masterpiece of Sansovino. What may be styled the tombstone of the old Campanile will be erected on an artificial mound in the public gardens in Venice. This memorial will be a pyramid thirty feet high, formed of perfect bricks of the old belfry, and is to commemorate the great collapse of July 14, 1902.

#### PROTECTING OUR WILD ANIMALS.

BY GEORGE ETHELBERG WALSH.

One of the problems of the day which all lovers of animals and birds are intensely interested in is the successful adoption of some adequate methods of preserving the native wild animals and birds that are threatened with extinction by thoughtless and ruthless hunters and ignorant people generally. The fauna of the North American continent was the largest and most varied of any in the world in the days of the earliest settlers; but a century of steady destruction of the finest specimens of the animals brings us to-day to a realizing sense that, if we wish to have any of these creatures among us in the wild state, systematic efforts must be made to protect them.

In recent years the general movement to protect our song and plumage birds from ruthless destruction has resulted in educating the public to a higher appreciation of the value of these harmless creatures. Most States have enacted laws now which amply protect the birds. In the interests of sport our game birds and animals have likewise received partial protection during the breeding seasons when the rate of destruction is the greatest. Consequently these innocent creatures are in no immediate danger of extinction. In fact, they are actually on the increase in those States where the bird and game laws are rigidly enforced. All that the small animals and birds needed was such protection from man's destructive tendencies in order to enable them to breed and live in the woods and fields. With a little more general protection, we may hopefully look forward to the time in the near future when our song birds will be as numerous as ever.

But there is a class of animals and birds which cannot be reached by the ordinary methods of State legis-

lation. The larger animals of the forest will not thrive well in captivity, no matter how the parks and zoological gardens may be arranged, and if kept confined they lose their native characteristics and degenerate in spirit and size. Gradually their extinction is inevitable. Legislatures may pass laws annually to protect them, but if they are deprived of their great natural habitats—the wild woods and forests—they will inevitably decline in numbers and die out. Their danger is not only from the hunter's rifle, but from the influences of civilization which are destructive to their existence.

So generally accepted is this fact to-day that efforts have been made in different parts of the country to protect the wild animals on large natural preserves where they can have all the freedom and comfort of a wild existence. In the great Yellowstone Park the national government possesses a vast empire of natural wilderness where all of the American birds and animals thrive in the most satisfactory manner. Although the government officers in the park have not been able to quell poaching and hunting entirely, they have succeeded in giving to the few wild buffaloes, deer and antelope comparatively ample protection. The domain is so large, and the temptation so great for unscrupulous hunters to enter the park for unlawful purposes, that infractions of the law are quite common; but under more stringent enforcement of present laws it may be possible to preserve indefinitely in the Yellowstone Park animals and birds that will be exterminated in almost all other parts of the country.

Recently there has been started a movement by the government to preserve the great forest reservations of the West from the destructive influences of hunters, settlers and woodmen. There are some 47,000,000 acres of these forests in the West which are under the control of the national government. Some of the woods have already been denuded of trees so that they would be of little value for preserving game; but most of them are almost as wild and unexplored as half a century ago.

That they will be preserved in part at least is now quite evident. The Forestry Bureau is making elaborate plans for protecting them from fires and the woodman's ax; but closely associated with their protection is that of the wild animals which roam through them. It is claimed by the experts that, if all game, whether of birds or animals, were protected in these great natural forest preserves of the national government, within another half century our fauna would be once more the finest in the world. These vast tracts of forest lands are the natural haunt of wild animals which refuse to breed and multiply in any small preserve or park. The freedom of the pathless woods seems necessary for their growth and happiness.

In view of the rapid denudation of our forests, and the destruction of nearly all the larger wild animals of the country the national government will soon be called upon to extend this protection to the hunted creatures which have been driven before the hunter's rifle to the most inaccessible recesses of the Northwest and Canada. Indeed the latter country has to-day become an asylum for many of our finest animals, and hunters annually seek them in this far country. There are parts of Canada which have never yet been explored, and in the limitless woods and forests north of us the wild creatures find the protection which nature gives them. Even a large remnant of our wild buffaloes have crossed the Canadian border and now feed somewhere in the loneliest parts of that country.

The protection of the birds and animals on the government forest preserves is one of the steps demanded to-day in the interest of science and humanity. In such places they would perpetuate their species far into the future. As matters stand to-day there are whole families and groups of wild animals which must soon become extinct if no provision is made for their protection in great natural forest preserves.

One of the greatest enemies to the wild animals in any woods or forest is fire. In the great Northwestern forests where fires annually consume thousands of acres of timberland small and wild animals are destroyed in such numbers that their race has become almost extinct. Unless there is water near at hand the animals are caught by the fire and killed. This destruction is peculiarly great in the fall of the year when the young creatures are just beginning to run around and enjoy themselves. They are unable to run a race with the fire, and eventually they are smothered to death or roasted alive. The question of preventing fires in the woods is one that lumbermen have considered carefully for years, but it is a matter that should appeal to the humanitarian as well as the utilitarian. Where there is one lumber mill or home of a settler burnt down by these fires there are ten thousand helpless animals and birds consumed in the fierce flames. Even on the government forest preserves these fires do a great amount of annual damage. Their prevention must be effected before either the forests or the wild animals can be preserved. As most of the fires start through the carelessness of railroads, hunters and set-

tlers, it is possible to enforce regulations and punishments that would gradually tend to abate them.

In addition to the present movement to interest the national government in the work of preserving birds and animals on the natural forest reserves of the West there is a pretty general effort on the part of private individuals to establish preserves for breeding and protecting the wild creatures that stand now in danger of extinction. Some of these private preserves have been established simply in the interests of science and humanity. Their owners have created for the animals a natural asylum where they can live and enjoy themselves. They are not thus protected for the sportsman or hunter, but to keep them from extermination so that in the future there will be fine specimens of their race to gladden the hearts of generations yet to come.

#### SCIENCE NOTES.

Prof. A. E. Wright, of the Army Medical School at Netley, has published the results obtained by anti-typhoid inoculation. It is demonstrated, so it is said, that fewer cases and fewer deaths occurred among those inoculated than among those untreated.

Prof. Lucien M. Underwood, of Columbia University, and Dr. N. L. Britton, of the New York Botanical Gardens, as well as other scientists, have been investigating the flora of this State, and have discovered a new plant, or rather a new variety of an old plant. Near the salt beds of Syracuse, N. Y., they found specimens of the *Cissa marina*, which by no means conformed to the well-known species. The new form has been named *Cissa marina Syracusana*.

For twenty-five years the indefatigable Catholic priest, Father Delattre, has been engaged in archaeological researches on the site of ancient Carthage, and now reports what he declares the best find made during this period. It is a white marble sarcophagus, 2.09 meters in length, partially covered with designs, that on the lid being a relief portrait of a woman, of rare artistic beauty. The sarcophagus belongs to the Punic period and is the work of a Greek artist. It is now regarded as the pièce de résistance in the well-stocked museum of the Pères Blancs in Carthage. The find was made in the necropolis near Ste. Monique.

The collection of physical apparatus which was left by the late George M. Hopkins has been given by his widow to the Adelphi College, of Brooklyn, New York, with a few exceptions, notably his optical lantern with its various attachments, with which he performed interesting experiments on the rare occasions when he could be induced to give public lectures. This has been given to his friend, Prof. W. LeConte Stevens, Washington and Lee University, Lexington, Va. The collection embraces most of the pieces of apparatus which are illustrated in "Experimental Science." The apparatus for the Adelphi College was selected from the collection by Prof. W. C. Peckham.

Victims of pulmonary complaints have heretofore been compelled to make inconvenient journeys to the higher altitudes in search of the pure rarefied air which is known to be so beneficial to them, but this is no longer necessary. It has been discovered that the air from limestone caves has all the characteristics of that of the mountains. This discovery has just been made use of in the location of a sanitarium near one of these caves, and the air for the institution is supplied from the underground caverns. This establishment is at Luray, Va., and the system of ventilation is arranged so that each room gets its own supply direct from the cave. The air of these caverns is of a very uniform temperature and remarkably pure and free from all germs and dust particles. In the warmest weather the doors and windows of this institution are kept closed, and a comfortable temperature of 75 degrees is maintained in spite of one of 90 or more encountered outside.

The Agricultural Department has begun a series of exhaustive investigations into the matter of cold storage. There are a number of mysterious manifestations which take place in a cold storage warehouse, and the government agents are endeavoring to ascertain the why and wherefore of these. For instance, it has been often noted that one lot of fruit will keep in fine condition for many months, while another immediately near will rot in a comparatively few days. This is particularly true of peaches. It has also been noticed that some peaches lose their delicate flavor very quickly in cold storage, while others are not affected in the least. In order to get at the facts, an agent of the Agricultural Department has been assigned to take a specimen carload at Fort Valley, Ga., and to make careful observation of the manner of picking and packing and to follow the fruit through the various stages through which it must pass on its way to a cold storage plant in Jersey City. Here the fruit will be watched carefully during its prolonged stay by the same agent, who will make a detailed report of his observations. The same programme will be carried out with other shipments of peaches as well as other fruit.

### PARIS METROPOLITAN RAILROAD—NEW SYSTEMS.

BY PARIS CORRESPONDENT OF THE SCIENTIFIC AMERICAN.

The Paris Metropolitan system, of which the first branch has been so successful, is to be greatly extended and completed within the next few years, so that eventually the whole city will be covered with a network of underground lines, and will be one of

of the system will permit an easy and rapid circulation through the city. The Right Bank has a greater number of lines than the Left, but the former has also a greater circulation. Besides, a project for a number of additional lines is now in preparation. The construction of such an extensive underground system throughout a city of the size of Paris will be one of the most important pieces of engineering work on record.

The North section, No. III., is the one which is now being completed, and is of special interest owing to the fact that it lies part in underground and part in an overhead structure. The latter was necessary, as the North and the East railroads, lying not far apart, each cross the northern part of the city in a wide cut below the street level, containing nine or ten tracks. The Metropolitan could either cross in underground or overhead, but the latter was preferred, as the underground would have to be constructed at a considerable depth in order to pass under the tracks.

This would cause a great difference of level in the tunnels and would oblige the passengers to mount and descend from one section to the other, which would be a great inconvenience. Accordingly the overhead structure, although the most costly, was finally adopted. The total length of the line is 6.6 miles, and that of the overhead, which crosses both railroads at once, is about 1.2 miles.

The overhead part is thus in the middle of the line, with a tunnel section on each side of it. The tunnel communicates with the overhead section by an easy grade, which allows the trains to mount without difficulty. There are twenty-three stations over the whole length, of which three are in the overhead part. The underground work has had many difficulties owing to the displacement and reconstruction of the large sewers, and the preparatory work took a considerable time before the tunnel could be begun.

The tunnel has about the same dimensions and section as on the existing Metropolitan, and there are a number of large underground stations at the points of connection with the former and of the bifurcation of the new tunnels to be pierced later, and here the width of the vaulting has been doubled from 23 feet to 46, which is a considerable width for an underground work. The whole of the tunnel is constructed in masonry vaulting, with the exception of the Rue de Rome station, where the Metropolitan passes above the West Railroad tunnel.

The overhead construction is formed of a series of trusses resting on cast iron columns of a tasteful design. This portion, 1.2 miles long, passes along a strip of free ground in the center of the boulevards, with the wagon tracks passing on each side; it is thus not close to the houses and does not interfere with the circulation. The platform is from 16 to 20 feet above the street level, and the pillars are spaced generally 22 feet apart. Each truss comprises the two main

beams with the cross I-beams which support the tracks; between the latter is laid a brick vaulting 9 inches thick. The truss thus formed rests at each end on a roller support which allows for expansion. At the stations, of which there are three, the middle portion is supported on the columns, and it is supplemented at each side by an extra structure supported upon solid masonry pillars, in order to increase the width and afford a platform on each side of the track. The staircases for mounting to the stations will be placed against the masonry pillars. The internal width of the trusses is 18.4 feet for the double track, and at the stations this is increased by 13 feet on each side. The station platforms have now been made 280 feet long instead of 245 feet as formerly, since the length of the trains has been increased. The trusses are generally 70 feet long, but as they cross the streets in a single span their length varies here; the longest spans, over the railroads, are 244 feet. The junction of the tunnel and the overhead structure is made by a cutting lined with masonry, which is partly covered over by a metallic roofing.

#### Sverdrup's Arctic Explorations.

Sverdrup, who returned from the Arctic regions soon after Peary, has given out statements of his work. Sverdrup spent the winter of 1898-99 in winter quarters at Ellesmereland, whence scientific expeditions were started with sledges. The summer of 1899 was unfavorable, and the "Fram" was obliged to return and pass the winter in Ellesmereland. A great part of the surrounding region was mapped out.

In May, 1900, there was a serious fire on board the "Fram." At one time it was thought that the ship would be completely destroyed. After a hard fight the flames were extinguished. In August, 1900, Jones Sound and Cardigan Strait were traversed. Winter quarters were established at latitude 76 deg. 48 min. north and 89 deg. west longitude. There was no lack of fresh meat, for the region abounded in reindeer. Polar wolves were brought back as specimens. The



PARIS ELEVATED LINE AND STATION PLATFORM.

The best provided in Europe in this regard. There will be eight different lines. No. I. is the present Metropolitan, which crosses the city from west to east from the Maillot Gate to that of Vincennes. It has two branches at the Place de l'Etoile which pass to the Dauphine Gate and the Trocadero. At the latter point will commence the new line No. III., while the Dauphine branch forms the commencement for line No. II. The latter, which is now nearly finished, starts from the Etoile and makes a semicircular tour through the northern part of the city by the exterior boulevards, ending at the Place de la Nation on the east. This line is partly underground and part on an elevated structure passing along the center of the Boulevard. The tunnel is now almost ready for the tracks, and the last spans of the elevated structure are being put in place. It is probable that it will be open for traffic about the end of the year. Line No. III. makes a similar half-circle through the southern part of the city; when joined to the preceding section it will, in fact, make a continuous belt-line around the city, running nearly parallel to the Belt Railroad, which passes around the fortifications. The line No. IV. lies entirely in the northern part of the city.

The main line which traverses the city from north to south is No. V. Another line, No. VI., also passes from north to south and somewhat parallel to the former, lying to the east of it. No. VII. branch lies in the northern part of the city, starting from the Palais Royal and making a turn to the east, and after passing the East Depot ends at the Place du Danube. The concession has only recently been obtained for No. VIII., passing from the Opera toward the southwest; it will cross the Seine twice and ends at Auteuil. While No. II. is almost finished and a part of it may be put in operation in October or November, No. III. will not be completed before 1905; No. IV., which is just commencing, may be finished by 1904; Nos. VI. and VII. in 1905-1907, and No. VIII. in 1908. When the whole is completed the *ensemble*

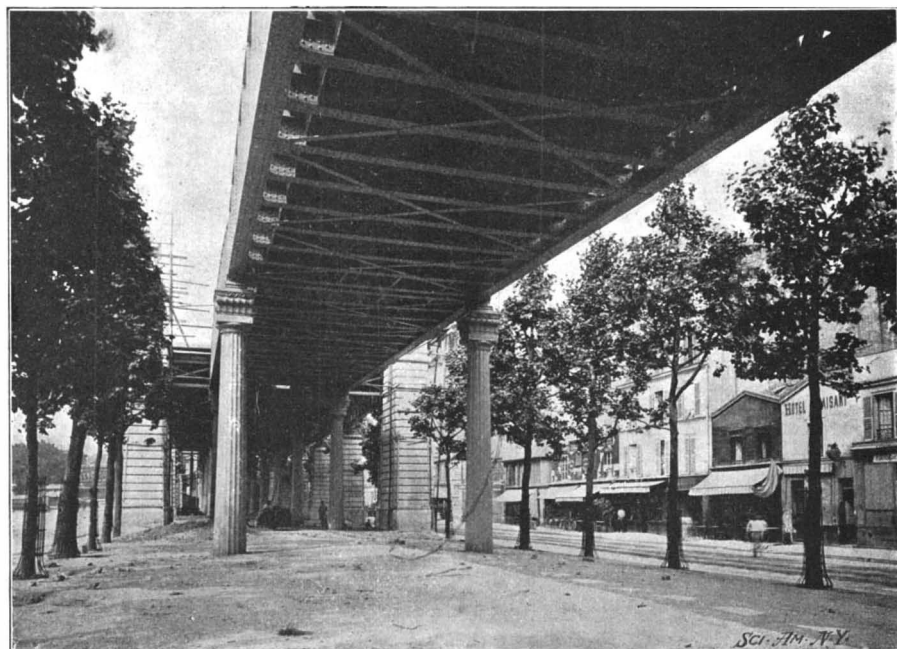

PILLARS AND STATION FROM THE STREET.

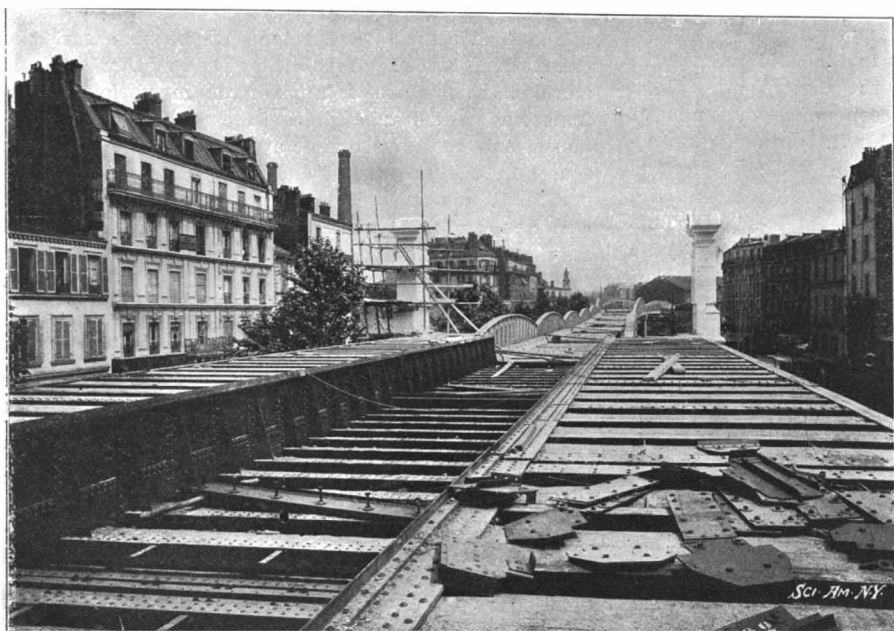

STATION PLATFORM, FOLLOWED BY REGULAR STRUCTURE.

following winter was more than ordinarily cold, the average temperature being 45 deg. below zero. During the spring and summer of 1901 and the early part of 1902 sledge expeditions were made. On the 6th of August the "Fram" succeeded in breaking away from the ice and reached Godhaven on the 18th. Cape Farewell was left on the 28th for home.

Capt. Sverdrup has rescued so much from the unknown and made so many solid additions to science that his achievements, taken in conjunction with the all-important part he took in the Nansen venture, entitle him to high recognition as an intrepid explorer. He carefully mapped out the region of the coast of Ellesmereland, which has been practically unknown, a task rendered peculiarly difficult by reason of the number of fjords, reaches and mountainous elevations. To the north of Peary Island a great island was discovered extending to about 80 deg. north; but no other land was seen either to the north or west of this island.

Dr. Redwood, a leading English chemist, is endeavoring to secure some legislation to compel the general adoption of use of oil as fuel in the city of London. With such action, he argues, the pall of fog under which the city frequently struggles would disappear entirely. The doctor says that the London fog is composed almost entirely of the unconsumed particles of carbon in the air emanating from the thousands of factory chimneys which are belching forth thick smoke for the greater part of the day. There is no soot from oil.



**ELECTRIC CALL.**

A matter of considerable importance in a hotel, and one usually dependent upon the memory of the clerk, is the calling of guests at desired hours. Negligence in this particular might put a traveler to serious in-

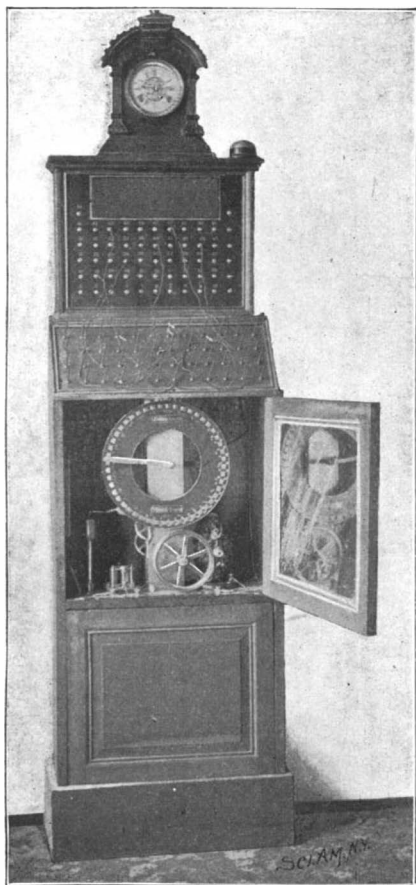

**AUTOMATIC MACHINE FOR CALLING GUESTS IN HOTELS.**

convenience, such as the missing of an important train, with its attendant complications. No such unfortunate circumstances can arise in a hotel equipped with the automatic electric call which is illustrated herewith. This machine is under control of a clock, and will automatically ring a bell in the room of a guest at any time set. The diagram of the parts clearly shows the electrical connections and the operations of the machine. A small electric motor, *A*, serves to operate a cam, *B*, and the contact finger, *C*, through the medium of a train of gearing which reduces their speed of rotation. The finger, *C*, which is electrically connected to one element of the battery, *D*, rotates intermittently, and, consecutively, at intervals of a quarter of an hour, engages the contact points on the disk, *E*. These contact points are respectively connected to a series of pins, *F*, extending upward from the top of the casing. Adjacent to these pins are a series of terminals, *G*, connected respectively with the alarm bells in the various rooms. Any of these terminals, *G*, may be connected to any pin, *F*, by a plug and cord connection so as to sound the corresponding alarm as soon as the finger, *C*, engages the contact point which is connected to that pin.

The motor, *A*, is controlled by the clock at the top of the machine. The striking hammer of this clock is actuated at every quarter hour to momentarily depress the spring-yielding contact piece, *H*, against contact, *H'*. This completes the circuit of battery, *D*, through magnet, *J*, energizing the latter and causing it to attract armature, *K*, which is thus brought into electrical engagement with contact post, *L*, a spring-catch, *M*, serving to temporarily lock the armature, *K*, in this position. An electric current now flows from battery, *D*, through post, *L*, armature, *K*, to brush, *N*, of the motor, *A*, thence through brush, *O*, back to the battery. The motor thus actuated operates the train of gearing which causes cam, *B*, to slowly rotate. The lever, *R*, which rests on the periphery of this cam, is rocked, causing the contact, *S*, to close on contact, *S'*, and contact, *T*, to close on contact, *T'*. By this act magnet, *U*, is energized, which draws back its armature, *M*, releasing the armature, *K*, and breaking the circuit through post, *L*. The motor, however, still continues to receive power through the contacts,

*S* and *S'*, until the cam, *B*, makes a half turn, when the lever, *R*, rocks to its normal position and the circuit is broken. The contact points along the periphery of disk, *E*, are forty-eight in number, one for every quarter hour, and the contact finger, *C*, is so geared as to make 1-48 of a rotation while the cam, *B*, is making a half turn, so that but one contact point is engaged at each operation of the motor. Now supposing a guest in room No. 10 desires to be called at 1:30. Connection is made between the terminal for room 10 and the contact pin marked 1:30. At 1:30 o'clock the finger, *C*, would have reached the contact piece marked 1:30, and a current would flow from battery, *D*, through finger, *C*, pin, *F*, and terminal, *G*, to the alarm bell in room 10 and thence back through wire, *W*, to the battery. Since the finger, *C*, is rotated very slowly, the alarm will continue to sound for a considerable length of time, which of course may be controlled by the gearing employed. The inventor of this machine is Mr. John Salmon, 240 West 23d Street, New York city.

**MODERN PILE DRIVERS.**

BY WALDON FAWCETT.

A very marked advance has been made during the past few years in the construction of pile-driving machinery. The evolution which has resulted in the production of the modern automatic steam pile hammer can scarcely be said to have been as rapid as that which has characterized development in certain other branches of the engineering field, but progress has been along lines no less revolutionary. It was inaugurated with the introduction of the main features of the old English Nasmyth hammer combined with an improved valve gear. Later a type of hammer made its appearance in which the number of parts was greatly reduced and the valve actuated by steam; but difficulty was found occasionally with the steam-moved valve, and this style of hammer was gradually supplanted by the most modern types, which are designed to combine effectiveness, strength, simplicity and positiveness of action.

Some of the chief characteristics of the latest approved model in pile-driving machinery embrace a simple and positive valve gear; a short steam passage and a quick and wide opening of exhaust, the latter enabling the avoiding of back pressure during the drop. In such a pile driver turned columns are provided connecting the cylinder and base and serving to guide the ram. The guide holes in the ram are bored

by the use of a "jig," and unfair strains on the piston rod are avoided. The piston is forged on its rod, and channel bars are attached on each side to enable the hammer to drive below the bottom of the leaders.

In order to perform the best work, a pile driver must be regular and continuous in its action. The machines now in use are capable of driving any kind

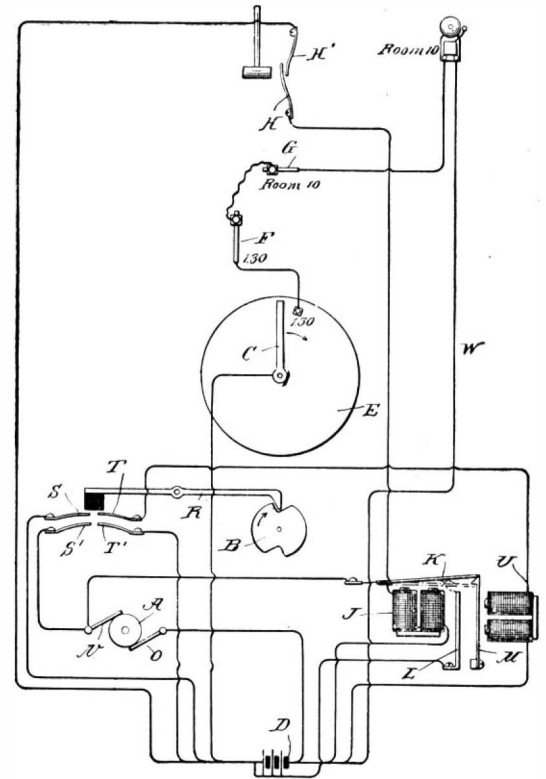

**DIAGRAM OF CONNECTIONS IN THE ELECTRIC CALL**

of pile, hard or soft, straight or crooked, and any pile may be driven in the hardest kind of driving sand or hardpan without injury to the head of the pile. Indeed, in the case of piles of spruce, bass and pine, the timber most frequently used, they may be driven without the use of bands. The operation of the modern steam hammer is simple in the extreme. The hammer is raised in the leaders—this being the only duty of the engine aside from hoisting the pile—and is allowed to rest its full weight upon the pile. Steam is then turned on, and the hammer pounds automatically until the pile is driven to the required depth.

The steam pile hammer of this type, which is used for foundations, docks and piers and other classes of heavy work, weighs almost 10,000 pounds, is 12 feet in length, has a normal stroke of 42 inches and is fitted with striking parts weighing 5,000 pounds. The hammer most extensively used in railroad work weighs 6,500 pounds, has a stroke of 3 feet and striking parts weighing 3,000 pounds. There are various intermediate sizes, and the smallest hammer of this general type has lately been provided especially for the purpose of driving fish-stakes for pound-nets along shore. This hammer weighs but 1,350 pounds, with a normal stroke of 2 feet and striking parts weighing 550 pounds. For the two largest size hammers engines of 40 and 25 horse power, respectively, are required.

Perhaps the severest exactions which have ever been imposed upon pile-driving machinery had to be met during the driving of piles for the Chicago post office. In order to fulfill the requirements of this governmental contract, the piles had to be driven to a depth of 70 feet below the surface in very hard material. Naturally an enormous number of blows had to be given—in some cases as many as 1,800 to one pile—and the problem of preserving the pile heads became a grave one. A steel plate was found advantageous for purposes of protection, and when it was discovered that there was more or less danger from this plate slipping and injuring the workmen, a hood with a recess was designed to hold the plate, forming a safe protector for the pile.

Although many advantages are claimed for the steam hammer over the old-fashioned drop hammers, the latter are still in use to a considerable extent, and the machines of this type have innumerable improvements over those in

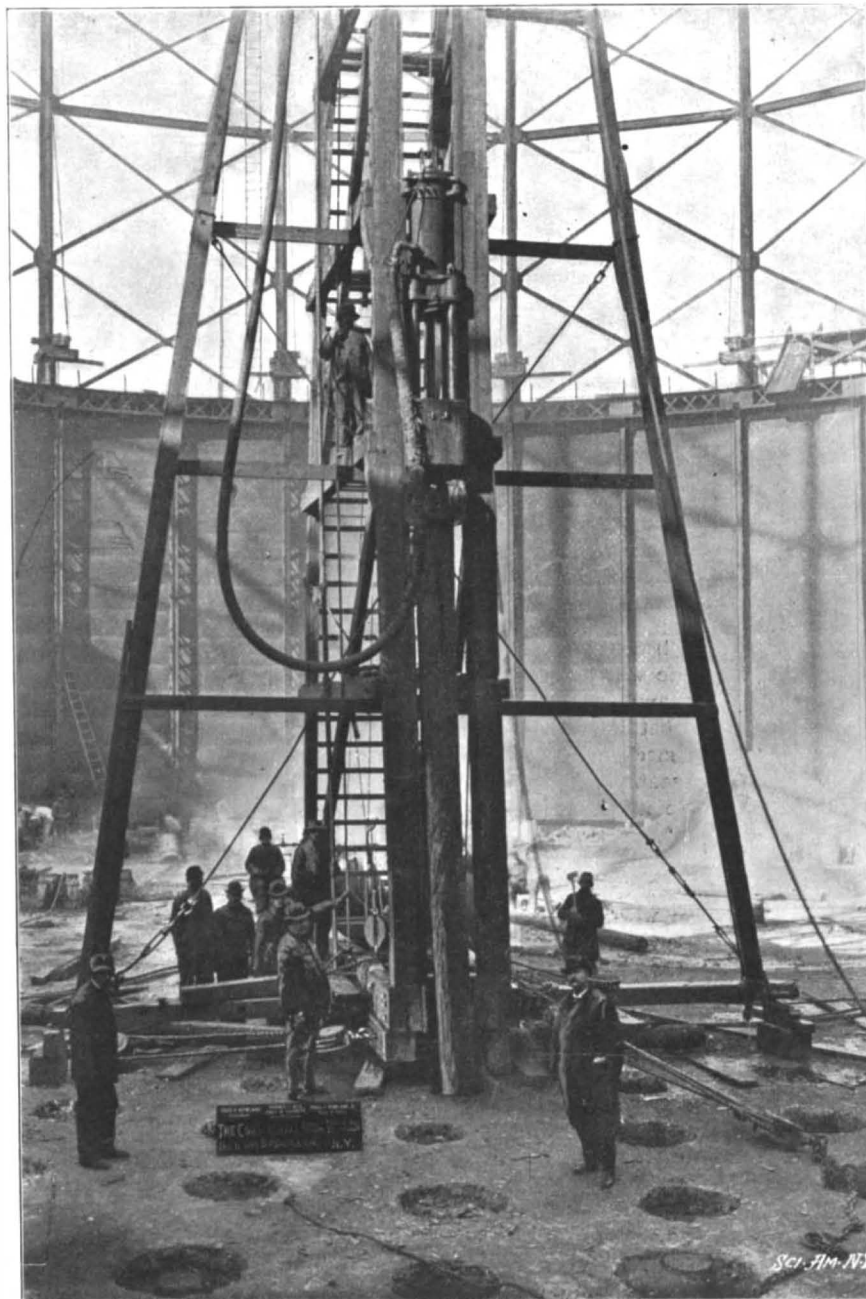

**A MODERN AUTOMATIC STEAM PILE DRIVER.**

use a few years since. For one thing, the hammer is much longer for given weight than the older forms, thus avoiding the sidewise throw when the hammer strikes near one edge, and it is so guided that instead of striking directly on the pile it works on an independent piece of wood which is inserted in an iron socket, so that the stroke of the hammer falls on the intermediate block, which transmits its force to the pile. This intermediate piece of wood can be changed when it splits, and by its use the head of the pile is preserved. The drop hammers range in weight from 75 to 5,200 pounds. In most cases they are concave in the bottom, although flat hammers are sometimes provided.

In the case of what is known as the "township" pile driver—a machine designed for use on small bridges and other light driving and fitted with a drop hammer weighing from 500 to 1,200 pounds—the hammer is usually raised by horse power, the smaller sizes being hoisted direct, that is, without a purchase block, and the larger sizes having one end of the line fastened to a suitable post, driven into the ground, when the other end is passed through a tackle-block which is fastened to the main hoisting line and leads to the whiffletree direct. In some instances use is made of a winch which is bolted to the ladder. Tackle-blocks can also be used instead of sheaves at the top and bottom.

The more powerful drop hammer outfits have usually of late years been used with friction engines. In an up-to-date equipment of this kind it is customary to provide woodwork of Norway pine and a head block of Georgia pine, oak or maple. In connection with drop hammers there is now used extensively a protecting cap which displaces the familiar pile band and has the advantage over the latter in that no time is consumed in its removal and there is practically no danger of the breakage of the device.

Many contracting engineers predict that the steam hammer will ere long almost entirely displace the drop hammer for pile-driving operations. While the stroke of the steam hammer is limited, yet the frequency of the blows, together with the constant weight of the machine on the pile, gives results that are surprising to persons whose experience has been limited to drop-hammer pile drivers. As an indication of the economy of time rendered possible by a steam hammer under certain conditions, it may be cited that recently, while contractors were driving piles for the L. & N. Railroad at Pensacola, Fla., fifty minutes' time was required to drive with a drop hammer a pile 75 feet in length, there being utilized 120 blows from the top of 75-foot leaders. The next pile, the same length and located but three feet from the one mentioned, was driven to the same depth by a steam hammer, which delivered the 130 blows required in ninety seconds.

#### SOME NEW DETECTORS FOR WIRELESS TELEGRAPHY.

BY A. FREDERICK COLLINS.

Invention, like all evolutionary progress, travels in cycles. Wireless telegraphy is no exception to this rule, as a review of the results achieved will show, for yesterday the workers were madly striving for syntonetic effects, while to-day electric wave detectors are engaging their attention, and to-morrow—only to-morrow will reveal the popular thought.

Of electric wave detectors there are two distinct types: (1) The familiar coherer in its many and varied forms; and (2) devices which depend upon the increase and decrease of magnetic permeability by the impinging electric waves setting up oscillating currents in the resonator system.

Mr. Marconi, Prof. Fessenden and others have taken up this latter type of detectors, since it offers not only a wide field for research, but it has been shown from theoretical considerations that in magnetic detectors as they are called, all the energy could be utilized, whereas in the coherer type only that portion of the energy could be utilized which is required to raise the potential to the critical point necessary to break down the maximum resistivity and the rest of the wave value is therefore lost.

To Prof. Elihu Thomson is given the credit of having first proposed the general principle embodied in electric wave detectors of the magnetic type. In Fig. 1, A, the simplest arrangement is shown in outline representing an elevation, and in Fig. 1, B, a plan of the magnetic detector is shown. In this form a silver

ring, 1, is suspended by a quartz fiber, and above the ring is attached a small mirror, 2, so that readings may be taken by means of a lamp and telescope just as in an ordinary reflecting galvanometer. The system is thus free to revolve between the parallel coils of wire, 3 3', which are connected in series. The opposite and free terminals of 3 3' of the coils are extended to or connected with the vertical wire, 4, and the ground wire, 5.

When the electric waves impinge on the antenna or vertical wire, 4, they set up high-frequency oscillatory currents, and these passing through the coils, 3 3', join a rapidly-alternating field between them; these magnetic lines cut through the suspended ring, and currents are induced in it, and these have a tendency to turn at right angles to the coils creating the magnetic field; and in following out this law of repulsion the ring describes an arc equal to the opposing forces. This was the form of detector Prof. Fessenden employed in his tests prior to his work for the government.

To bring this detector into a more practicable form, so that a telephone receiver could be employed instead of the reading telescope, the instrument is somewhat differently designed and constructed from that shown in Fig. 1, though the principle is the same.

In this case the metal ring, 1, Fig. 2, rests upon three inverted wedges, 2 2' and 3; 2 2' are of metal, but 3 is of carbon. One terminal of a non-inductive resistance, 4, is connected to the inverted metal wedges, 2 2', and the opposite terminal is connected in series to a telephone receiver, 5, and this in turn to the carbon wedge, 3. The electric wave system is formed by connecting the vertical wire to the metal wedges and the earthed wire to the carbon wedge. With these

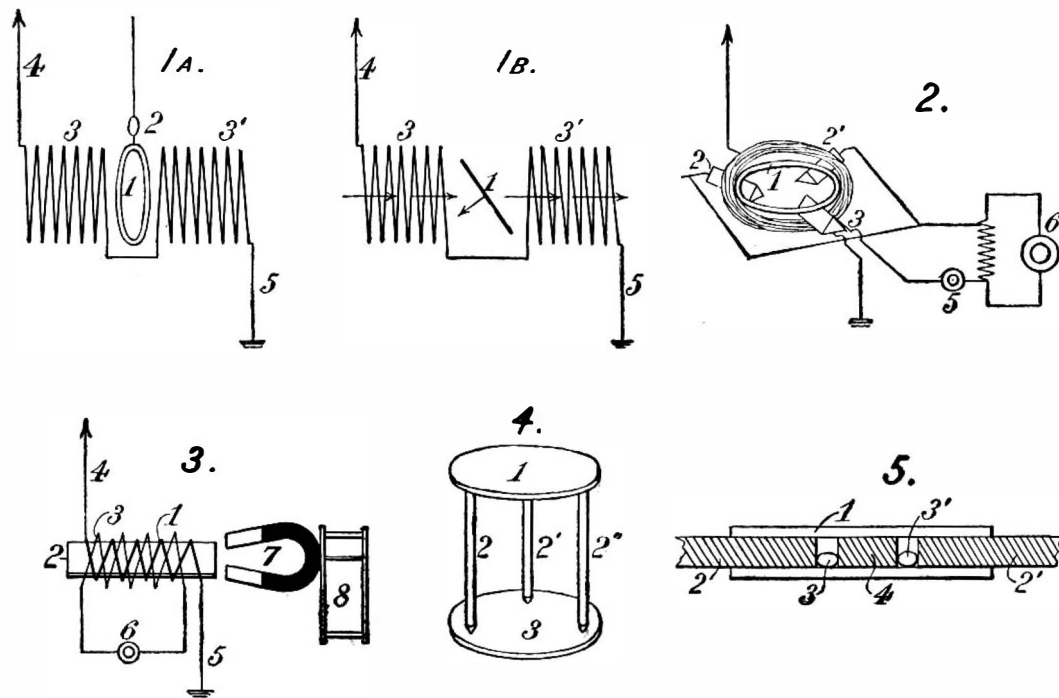

Fig. 1 A.—Fessenden Detector (Elevation). Fig. 1 B.—Fessenden Detector (Plan). Fig. 2.—Magnetic Detector. Fig. 3.—Marconi Magnetic Detector. Fig. 4.—Branly's Tripod Coherer. Fig. 5.—Castelli's Coherer.

arrangements completed an alternating current from the dynamo, 6, is switched through the circuits; this produces a continuous vibration of the diaphragm of the telephone receiver, but when the electric waves impinge on the vertical wires the resistivity of the carbon wedge is varied and any change in it is registered by the telephone.

In Mr. Marconi's recent paper he describes a new form of detector which likewise depends upon a varying magnetic field produced by high-frequency oscillations transmitted from a distant point in the form of electric waves; but the electrical feature which places the stamp of originality on this new detector is the fact that it calls into action magnetic hysteresis.

In mechanical construction the Marconi detector is comparatively simple, consisting as it does of a layer of fine insulated copper wire, 1, Fig. 3, wound on a core, 2, made of thin iron wires; a second layer of fine insulated wire, 3, is wound over the first, forming a secondary coil. The ends of the inner coil are connected with the vertical wire, 4, and to the earth, 5. The terminals of the secondary coil are connected in series with a telephone receiver, 6, or other suitable receiving instrument. Up to this point it will be observed that there is but little difference in Marconi's device and those heretofore described, and all of them are based on the researches of Prof. Joseph Henry, who produced with a single spark from the prime conductor of a frictional machine an oscillatory current at a distance of 30 feet, sufficient to magnetize steel needles. But in applying the principle of hysteresis an entirely different detector results, and to understand this process the better, let it be known that the ascending and descending curves described in magnetic tests of iron do not coincide, and this being true it is self-evident some work is done, and this takes

the form of heat; although practically it is so small as to be negligible; this process of hysteresis, it now appears, has the curious property of accentuating mightily every charge, however small, in oscillatory currents, set up in a resonator by the incoming electric waves.

Now in order that the bundle of fine iron wires forming the core of his detector may be constantly following a cycle of increased and diminished magnetization or continued hysteresis, Marconi causes a horseshoe magnet, 7, to revolve before the pole of the core by clockwork, 8. The magnet should be revolved very slowly—at the rate of one revolution every two seconds; the speed of course varying for the different qualities of iron employed; and in this way a slow and constant change with successive reversals of the magnetization results.

It might be supposed that the changes of polarity of the core would induce currents in the secondary coil of the detector which would be rendered audible by the slow motion of the magnet, and that if it were revolved at a high rate of speed better results would be obtained. This, however, is diametrically the opposite of what takes place in practice. The writer had occasion to make some experiments with an inductor type of alternator. With a telephone receiver in series with one of the windings, it was noted that when the rotor was turned by hand the reversals of the current were not noticeable and articulate speech exceedingly clear; but when the rotor was coupled to a gas engine and revolved rapidly a continuous hum in the receiver was apparent. These cases are identical.

The great advantage of the magnetic detector, as Mr. Marconi has pointed out, lay in its self-restorative qualities, and that its resistance is practically the same at any moment, whereas in a coherer before and after tapping there is always a wide and variable resistivity affecting the working of the registering instruments. It is claimed for this new detector that it is exceedingly sensitive and more reliable than the coherer, the latter being especially desirable in connection with syntonetic wireless telegraphy.

While these points are advantageous, yet it would seem that the wide divergence between resistivity and its reciprocal, which is necessary in a detector to enable a relay to be operated, is in the magnetic detector lacking, and the limit of its usefulness will be confined to the telephone as a receiver; this may be of greater advantage than otherwise, since by means of the telephone wireless message may be read more rapidly and at a greater distance than when the more cumbersome, costly and slower Morse register is used.

Let this be as it may, experimental research is still going on with the type of detector that first made wireless telegraphy possible—the coherer.

Mr. Edouard Branly, of Paris, in his paper on "Variations of Conductivity," published in 1900, showed for the first time the effect of electric sparks on powdered metal inclosed in an ebonite tube; this tube he termed a *radio-conductor*, and was the first real coherer; and now he has given the results of his further researches in the form of a new coherer. To a metal disk, 1, are attached three metal rods, 2 2' 2'', Fig. 4, with their points resting on a second disk of polished steel, 3. The points of the rods are oxidized. The success of the Branly coherer depends entirely on the oxidation of the metal points and the polish of the steel disk. The film of oxide may be preserved for a considerable length of time. Like Marconi, Branly has searched for a detector of stability greater than that offered by the ordinary coherer, in which the multiplicity of contacts gives rise to miniature trains of electric waves; in the Branly tripod this is largely avoided. It requires a slight tapping to decohere it.

The details of another new coherer, designed by Signor Castelli and used in the Italian navy, and which is said to have been employed by Marconi in his recent transatlantic tests, have been made public. The Castelli coherer consists of a tube, 1, Fig. 5, having its two terminal conductor plugs, 2 2', oppositely disposed in the coherer tube and separated by two pockets, 3 3', the interior plug being made of iron, 4. Into the pockets are inserted globules of mercury. The tube is self-restoring and in practice stands up well for regularity and rapidity.

The recent developments in wireless telegraph instruments would not seem to indicate the need of



electric wire detectors of any greater sensibility than those already in use; but a detector having a range of variability sufficient to operate a sensitive relay at ordinary distances from the transmitter with certainty, and having the added quality of being self-restoring, is a thing much to be prized.

In this a new field is opened in wireless telegraphy, in which the favored one who invents it will be highly rewarded.

#### THE MANUFACTURE OF TIN PLATE.—I.

In the last two decades of the industrial development of the United States there have been some remarkable instances of the creation of new industries within incredibly short periods of time, and among these perhaps the most striking is the birth and growth of tin-plate making. Less than a dozen years ago, the United States were dependent entirely upon the tin-plate makers of South Wales, England, for their supply of this invaluable commodity; but under the stimulus of a protective tariff, several tin-plate works were laid down early in the nineties, and we entered upon the experiment of supplying our own markets with the home-made product. The experiment was pre-eminently successful; for by the use of improved machinery, and by the application of our own system of shop management, we have developed an absolutely new industry to such proportions that to-day the supply is in excess of the demand.

The manufacture of tin plate divides itself naturally into two main parts. First, the manufacture of the sheet-iron plate, and secondly, the tinning of the plates. The present article is devoted to the first of these processes.

For a description of this new American industry, we have chosen the Laughlin Works of the American Tin Plate Company, which are situated at Martin's Ferry, Ohio. These works are the latest and among the largest of those controlled by this corporation, and they represent the most advanced practice in this country.

**Hot Rolling.**—The raw material comes to the works in the shape of sheet bars, which are 8 inches in width and vary from  $\frac{1}{4}$  to  $\frac{3}{4}$  of an inch in thickness, according to the desired thickness of the finished plates. The steel is a soft Bessemer, carrying from 0.08 to 0.10 per cent of carbon. The bars are cut into lengths equal to the width of sheets desired— $\frac{1}{4}$  to  $\frac{1}{2}$  inch being allowed for side scrap. We will follow, in explaining the process, the execution of an order for size 20 by 28 inches; in rolling other sizes the figures differ proportionately. The rolling is always done across the bar, that is to say, the flow of the metal is in the cross direction to that which took place when the bar itself was being rolled at the steel mills, and all the rolling at the tin-plate mills is done in one and the same direction. The process of rolling is as follows: The bars are heated in a furnace to a cherry red, and are then rolled singly, each being given five passes through the rolls, until they have increased to sheets about 28 inches in length. These are then put in the sheet furnace in pairs and heated, and the pairs then given two or three passes through the rolls, until they are drawn down to about 56 inches in length, the width remaining about the same, or  $20\frac{1}{4}$  inches. They are then taken over to the doubling shears, which are located conveniently to the rolls and the furnace, and doubled over, making four thicknesses. At the same time the ends are trimmed and the pack of four is returned to the furnace, heated, and again drawn out, this time to a length of about 54 inches. It should be mentioned that between each rolling, the plates, which have become more or less stuck together, are opened while they are hot, there being a tendency for the plates to weld together from pressure. This allows formation of oxide on the surface, which assists in preventing further sticking. The four-fold 54-inch plates are then put under the doubling shears, doubled again, and the ends trimmed. The pack of eight sheets is now put back in the same furnace and given its fourth rolling, under which it is drawn out to the finished standard length of 56 inches. The packs are then piled on the floor ready for the shears. An eight-hour shift will turn out from 5,500 pounds to 7,000 pounds, according to the gage of the plate that is being rolled. This forms the completion of the hot-rolling process.

**Shearing.**—The plates are then carried to the squaring shears, where each pack of eight is cut through the center, and the two halves are placed with their cut edges against a gage and sheared to the desired length of 28 inches, the edges being also squared up against a gage set at 90 degrees from the shears. The result is sixteen 20 x 28 perfectly square black plates.

**Opening and Black Pickling.**—The packs of eight sheets as they come from the shears are passed on to long benches in front of which stand the openers, as the hands are called whose duty it is to open the sheets, which have become somewhat stuck together under the process of rolling and shearing. The openers have stout leather half-gloves on their hands and, standing the plates on edge, by a deft movement of the

hand, they quickly strip the plates one from the other. From this time on, each plate is handled separately throughout the whole process, and to this fact is to be attributed a great deal of the expense of its manufacture. As they are opened, the sheets are piled on carriers and taken to the black picklers, where they are treated in a bath of hot sulphuric acid to remove all scale and oxide from the surface; for to secure a perfect coating of tin plate it is necessary to have an absolutely clean surface. The pickler consists of a large hollow vertical shaft, which carries at its top three horizontal arms. From each arm is hung by chains a crate for holding the black plates during the pickling process. The central shaft is provided with piston rings, and moves in a steam cylinder that is bolted to the floor of the building. By means of a trip valve, the operator is able to give the shaft, with its burden of black plate, a vertical oscillating movement. After a load of plates has been placed in one of the crates, it is picked up, swung around and lowered into a bath of hot sulphuric acid, where by the vertical movement of the crate it is thoroughly agitated, and the acid given a chance to act on every portion of the plates. After from four to ten minutes of this washing, according to the condition of the plates, the crate is lifted from the acid vat, swung around, and lowered into the "swill" or fresh-water vat, into which a constant stream of water is kept flowing. In the meantime another crate has been loaded and swung into the pickle vat, thus giving a continuous operation.

**Annealing.**—The pickled plates are then taken from the fresh-water vat, removed from the crates, and packed in the annealing stands. The latter, as shown in one of our accompanying engravings, consist of a lower tray and an upper cover or box. The wet plates are piled on the stand, the heavy cast or wrought iron box is then lowered over them, and sand is carefully packed in between the edges of the tray and the bottom of the covering box to exclude all air. The annealing stand with its load of plates is then picked up by a huge, counterbalanced, gooseneck, charging crane, and run into the furnace in the manner shown in our illustration. Under the old system of handling these heavy annealing stands, it was customary to use a heavy wrought-iron, hand-operated truck, which required several men to work it; but by means of the ingenious counterbalanced crane herewith shown, one man is able to swing the crane and its load, and direct it into the proper position in the furnace. The black plates are piled up in the annealing stands to a height of from 20 to 48 inches. They are subjected in the annealing furnace for from twelve to eighteen hours to a temperature of 1,500 degrees. The annealing is one of the most particular steps in the manufacture of tin plate, since overheating would make the plates stick, and if they are underheated the plates would not be thoroughly cleared and softened. The effect of the annealing is to soften the plates and to take out the uneven strains which have been produced during the rolling, and also to remove all stains from the plates. As the latter enter the furnace thoroughly wet, the moisture is converted into steam and they are subjected to a very effective steam bath, which serves to remove the acid and other stains from the plates, and give them the desired clear, white appearance. After the plates are removed, they are allowed to stand until they are cold.

**Cold Rolling.**—When they are cold, the plates are carried in the stands to the cold rolls, where they are passed singly into the rolls. The object of this rolling is to close the pores and give a smooth, hard surface to the plates. Each plate is given two or three passes, which is usually sufficient to produce the desired finish. Since the cold rolling has the effect of stiffening the plate, another annealing becomes necessary. For this purpose they are packed in the same way as for the first annealing, with the exception that in this case the plates enter the furnace perfectly dry. The temperature, moreover, is lower, 1,200 as against 1,500 degrees, and the plates are not kept in the furnace for over six or eight hours.

**White Pickling.**—As soon as the plates have been removed and cooled, they are treated to what is known as white pickling, which is similar to the black pickling except the acid solution is weaker. The white pickling is necessary for the removal of the small amount of oxide which has accumulated during the annealing and cold rolling. After the white pickling great care is taken to protect the plates from the action of the atmosphere, for it is important to preserve the clear white surface which is produced by the pickling until the plates have entered the tinning pot. Hence, the instant they are taken from the white pickling vats, the plates are loaded into wheeled tanks, known as water-boshes, and in these are taken to the tinning house, a description of which will be given in a later issue.

The only musk ox in captivity in this country died recently at the New York Zoological Gardens. There is only one other musk ox in captivity, and that one is to be found in the Zoological Gardens of Hamburg, Germany.

## Correspondence.

### Soft Coal for Domestic Use.

To the Editor of the SCIENTIFIC AMERICAN:

I have just read your article relative to the use of soft coal, in your last issue. It sounds odd to those who live where we use soft coal for all purposes, to be told that we cannot depend on banking fires to keep over night. We find no trouble; all that is needed is a large piece of coal and a door a little ajar. In the morning knock apart the chunk and your fire freshens up. The large piece is preferable but not absolutely necessary, for plenty of small coal can be treated in the same way. If your people will put in good down-draft furnaces for soft coal, they can burn so much of the smoke as to have very little if any trouble from soot.

H. C. HAMMOND.

Olathe, Kans., September 22, 1902.

### Soft Coal for Domestic Use.

To the Editor of the SCIENTIFIC AMERICAN:

I notice that in the SCIENTIFIC AMERICAN of the 20th instant you say on page 182: "Owing to the rapidity of combustion of bituminous coal, it will not be possible to bank up the furnace for the night and leave it with the certainty that there will be a live fire remaining in the morning."

I have had nineteen years' experience in the exclusive use of soft coal for domestic purposes, and for about thirteen years my home has been heated with a hot-air furnace in which soft coal has been used almost exclusively. My experience is that there is no more difficulty in keeping a fire over night with bituminous coal than with anthracite. Indeed, I have several times kept a fire for forty-eight hours in my furnace without any attention whatever. If the lower and upper drafts are both left a little open, and there is a good body of coal, and especially if a pretty brisk fire is well covered with fine coal, a furnace fire will keep as long with bituminous coal as with anthracite.

I have also kept a fire for weeks at a time in an open grate with bituminous coal, simply taking care to have a good fire at bedtime and cover it with fine coal or ashes, preferably the latter. It will not go out for twelve hours, and at the end of that time it may be raked down and broken up on the top, and it will soon give you a cheerful blaze. The same stoves that are used for anthracite coal can be used for bituminous. Of course in this country the soft coal is so very much cheaper than the anthracite that the latter is a rarely used luxury. This section of the State of West Virginia can also furnish a cannel coal almost equal to the best imported, if not, indeed, quite equal to it.

J. O. THOMPSON.

Sec. West Virginia Farm Review.

Charleston, September 23, 1902.

### The Trial of Spencer's Airship.

Stanley Spencer is the latest foreign aspirant to aeronautical honors. On September 20 he traveled nearly 30 miles over London in an airship of his own construction. He seems to have had a rather hard time of it during his flight, for he was in constant danger of an explosion of the balloon and of ignition of the hydrogen gas by the motor. He states that his machine could be easily controlled. As he sped over London the inventor dropped balls. Spencer's airship is said to differ from Santos-Dumont's in being constructed on the Hiram Maxim system. The machine is pulled along instead of being propelled from the rear. The framework is of bamboo, the parts being lashed and bolted together. The total weight of the contrivance is less than 300 pounds, of which 125 pounds fall on the frame. The driving power is furnished by a Simms petrol-motor of 35 horse power. The gasbag is 75 feet in length. During his flight over London, Spencer attained a speed of  $7\frac{1}{2}$  miles an hour.

### The Passing of the Fire Engine.

At a convention of the International Association of Fire Chiefs, held in New York city, the Chief of the Baltimore Fire Department read a paper on the fire departments of the future in large cities. The paper started a discussion on the merits of mobile fire engines as compared with stationary pumping plants, stand pipes, and sprinkler systems. The Chief of the Chicago Fire Department declared that ninety-two steam engines in Chicago could be dispensed with if twelve pumping stations were at hand. A representative from Boston gave it as his opinion that the clang of the engine through the cities' streets will soon be as out of date as the old vamp brake pump.

### Chullapata Volcano Active.

A dispatch from Lima, Peru, states that Mont Chullapata, 18 miles from Celendin, has been vomiting volcanic dust and smoke for the last fortnight. Several earthquakes have been felt around the mountain, and great chasms are said to have been opened in its sides.

### THE MANUFACTURE OF THE NEW FIREPROOF MATERIAL URALITE.

BY THE LONDON CORRESPONDENT OF THE SCIENTIFIC AMERICAN.

Some interesting experiments have been carried out in England with a new fireproof material called "Uralite." It originated in Russia, being the invention of Col. Ichenetsky, of the Russian artillery, and takes its name from the Ural Mountains, where a large quantity of asbestos, which constitutes the fundamental component of uralite, is obtained. It has proved a highly efficacious fire-resisting material, capable of withstanding a much greater degree of heat, without exhibiting any apparent effect, than any fireproof material at present on the market. Coupled with this fact it is extremely light, is of great strength, is durable, and is manufactured in sheets of varying sizes and thickness, thus rendering it a first-class material for building purposes. Another recommendation in its favor is its extreme lightness.

Although asbestos enters largely in the composition of uralite, it is by no means the only important substance incorporated in its manufacture, since asbestos in its pure form, although it will resist high degrees of heat, is liable to disintegrate under the influence of excessive temperature, and this peculiarity to a great extent nullifies its utility.

The asbestos in its raw state is thoroughly cleansed, so as to free it entirely from sand and other impurities of a similar nature. It may be mentioned incidentally that both the Russian and Canadian products are employed, though the former is preferable owing to the greater strength of the fibers. After cleaning, the asbestos is passed between rollers fitted with short, sharp projecting pegs which tear the fibers of the

used; if gray, the whiting is toned down with a quantity of carbon black; and if the article is to be red in hue, red oxide is added to the whiting. The latter material is first beaten into a stiff cream, by throwing the dry material with a quantity of water into a mixer. When the proper consistency has been obtained, the cream is passed through a sieve, by which means all foreign objects such as pieces of wood and so forth which may have been incorporated in the mixture are removed. From the mixer the whiting is passed into a large hollander containing the asbestos, and the two components are beaten up into an emulsion and thoroughly mixed. The mixing is accomplished by means of revolving screws and propellers. In this machine again care is observed to prevent the rotating blades tearing the fibers of the asbestos.

From the hollander the emulsion issues into a stuff chest, where the mixing is continued to prevent the settling of heavier material, and thence passes into another mixer, where the mixture is mixed with a quantity of water in the proportion of one of the latter to three of the former. It is thoroughly beaten into a pulp by revolving blades, the process being somewhat similar to the manufacture of pulp for paper.

From the mixer the pulp flows into a trough and thence passes into what is called the millboard machine. A roller revolves in this trough and drives the pulp over a sheet of rubber onto another large revolving roller covered with gauze. As this roller rotates it becomes covered with a sheet of pulp, the thickness of which is gaged by a regulating rubber-covered roller pressing against the gage roller. The usual thickness, however, is 1-50 inch. As the pulp passes over the latter roller, the water drains through the gauze and is carried away to a tank to be used again.

By passing between these two rollers the mixture is converted into a soft, damp sheeting of pressed pulp, and as it passes from the rollers it is carried upon an endless felt blanket, and upon this is conveyed over a number of rollers which drive out any water present in the substance and finally deliver it onto a large collecting roller at the end of

the machine. The uralite sheeting on the collector roller is practically a veneer, being only 1-50 inch in thickness, and the material is now built up to the desired thickness by superposing the sheets and cementing them firmly together so as to form one homogeneous whole. When the uralite is collected on the collector roller the substance is brought into contact with a felt-covered roller steeped with a solution of colloidal silica, gathered from a trough con-

taining the chemical solution in which the roller rotates. The colloidal silica is a composition of solutions of water glass and sodium bicarbonate. In this manner the uralite can be built up to any desired thickness, and when the latter has been attained a



AFTER THE FIRE. WOOD PLATFORM DESTROYED, URALITE PLATFORM INTACT.

knife is automatically brought into service and cuts through the sheet, which is removed to an endless belt, and is thus conveyed to a cutting table, where it is divided into conveniently sized sheets measuring about 6 feet 2 inches by 3 feet 1 inch.

Of course, during all these operations the material is tolerably damp, but at the same time it can be handled and cut without danger of tearing. The sheets after being cut up into sizes are stacked into a pile with a wire mat and an iron plate alternately interposed between each sheet of uralite, to prevent a sheet coming into contact with its neighbor. The pile is built to a height of about 3 feet 6 inches and is then transferred intact to a hydraulic press, and subjected to a gradually increasing pressure until the maximum of some 200 pounds per square inch is attained. This abnormal pressure is maintained for about 90 minutes, after which the pile is allowed to stand for 24 hours to harden. At the end of this period they are taken in hand once more for the next operation—stoving. Each sheet is now placed vertically with a thick skeleton wire frame between to protect it from its neighbor. The stoves are of huge size, ranged in three tiers, and the sheets are placed therein mounted on trucks. Heating is achieved by means of producer gas. The stoving operation is a very protracted one, since drying has to be accomplished very slowly. The trucks containing the sheets are inserted at the cooler end of the uppermost tier, where the temperature is 20 deg. C., and gradually removed along toward the hotter end, where the thermometer stands at 75 deg. C. The thick skeleton frames between each sheet of uralite permit the moisture as it is evaporated from the sheets to pass away. When the highest heat in the top tier has been reached—the process occupies 24 hours—the sheets are transferred to the second tier at the cooler end, where the temperature is 35 deg. C., and gradually working in the same way as before toward the hotter end—120 deg. C.—an operation also lasting 24 hours. The second stoving accomplished, the sheets are transferred to the cooler end of the lowest tier in a temperature of 100 deg. C. and gradually removed along once more toward the hottest end, where the temperature is 250 deg. C.—a process involving another 24 hours. Complete stoving therefore occupies no less than 72 hours.

After stoving, uralite is subjected to further chemical treatment to insure stability. The truck of sheets just as it emanates from the stoves is lowered into a

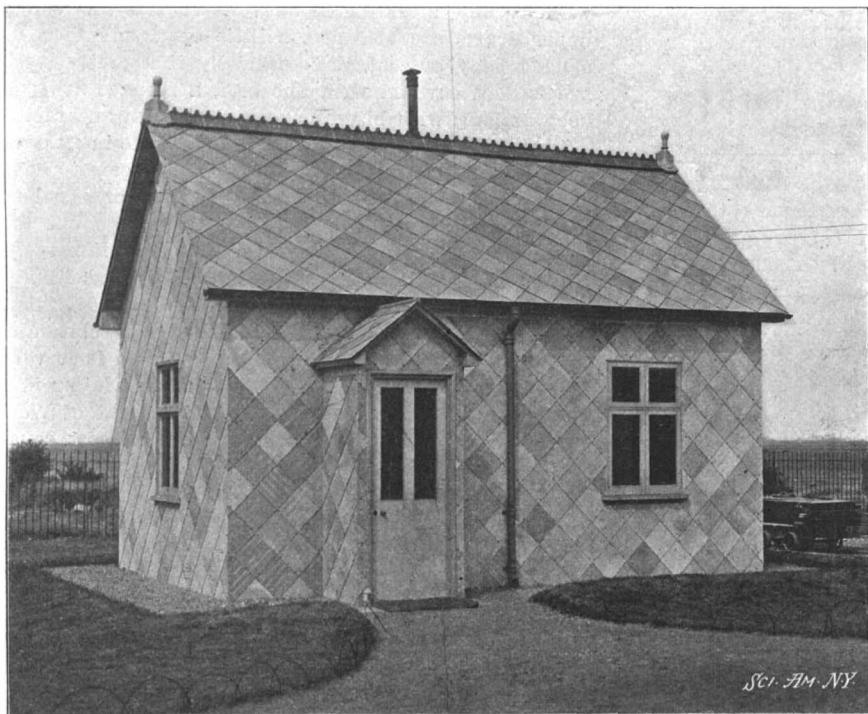

FIREPROOF HUT, CONSTRUCTED THROUGHOUT OF URALITE.

material to pieces during its passage between the rollers. As the disintegrated asbestos issues from the machine a blast of air plays upon it, and the disintegrated fibers are carried into a trunk to the underside of which hoppers are fitted. The light separated fibers are blown a considerable distance by the air into the trunk and fall into the bins farthest away from the machine, while the heavier matted pieces fall into the hoppers nearest the separating machine, and are once more passed through the rollers.

The finely-separated fibers in the other bins are thrown into another mill containing whiting in the proportion of 1 to 6. In this machine the fibers of the asbestos are still further separated, but at the same time extreme care has to be taken to prevent its being reduced to powder, this being obviated by the addition of the whiting. The length of the treatment of the material in this mill varies with its condition, the finer grades from the previous machine only wanting a few minutes' treatment, while the coarser grades require longer manipulation.

From this second mill it is conveyed to a Krupp disintegrator, while the fibers are loosened pretty thoroughly, though not absolutely, and the air blast is once more requisitioned in connection with this process. As in the first instance, the air blast carries the lighter portion of the material and deposits it in the most remote hoppers, while the heavier masses fall into the bins nearest the machine.

Now that the asbestos has been thoroughly disintegrated, the manufacture proper of the uralite commences, and this is the parting of the ways. The material is made in different colors, and upon its arrival in the mixing room, although the process of manufacture is largely the same, different materials have to be employed to supply the desired color to the article. If white uralite is required, whiting is



URALITE DOORS OF HUT, RESISTED FOR 1½ HOURS A TEMPERATURE OF 2275 DEG. F., PASSING NO FLAME.



tank filled with sodium silicate, and remains immersed therein for two hours. The sodium silicate for this purpose is supplied as solid glass, containing about 70 per cent of silica, and is thus practically insoluble in cold water, but when the substance is digested at 60 pounds in a boiler, it dissolves in a few hours. When the uralite has become thoroughly impregnated with the sodium silicate, it is permitted to stand for a time to enable the superfluous solution to drain away. This accomplished, the sheets are once more stoved for 36 hours in a low temperature, and then re-dipped in another solution of bicarbonate of soda for 24 hours, which bath decomposes the silicate of soda. The uralite is then washed for two hours in another tank and once more stoved. These chemical impregnation processes exercise a powerful hardening effect upon the substance, but to insure absolute stability the sheets are again steeped in the baths of silicate and bicarbonate of soda respectively, washed and stoved. The sheets are then finally immersed in a solution of calcium chloride to remove the remaining traces of the soda. It is desirable that this latter chemical should be entirely removed, since if it be allowed to remain a white efflorescence appears on the surface of the material, which though not deleterious to the material is unsightly, although it will disappear after a short exposure of the uralite to the weather. This protracted chemical treatment of the uralite converts it into a solid, homogeneous mass, which cannot laminate, has no planes of cleavage, and is fire-resisting to the highest degree.

The most noticeable feature of uralite is the facility with which it may be handled and adapted to other materials as a protection against fire. It can be glued and nailed without any fear of its splitting during the latter process. It is specially available for paneling or other similar purposes, and can be grained or otherwise treated precisely as if it were wood. It does not swell or shrink under fluctuating climatic conditions, is waterproof, and is a complete electric insulator. The remarkable immunity of the material from climatic changes may be gathered from the fact that a piece of the substance may be plunged into boiling water and then immediately steeped into frozen mercury without showing any shrinking, disintegration or other change, physical or chemical. It is capable of withstanding a great strain—18 tons per square inch in comparison with Portland cement, which is only capable of supporting 9 tons—so that it is an ideal material for floorings and ceilings. Its cost is very low—7 cents per square foot.

A practical proof of faith in the fire-resisting capabilities of uralite is attested by the fact that in London the fire insurance companies have decreased their rates where

this material is employed from \$5.25 to \$1.90. It is being adopted on the overhead railroad of Liverpool; in the Soudan for roofing purposes; and also by the Russian Admiralty.

The refractory properties of this new substance are vividly demonstrated in the accompanying illustrations.

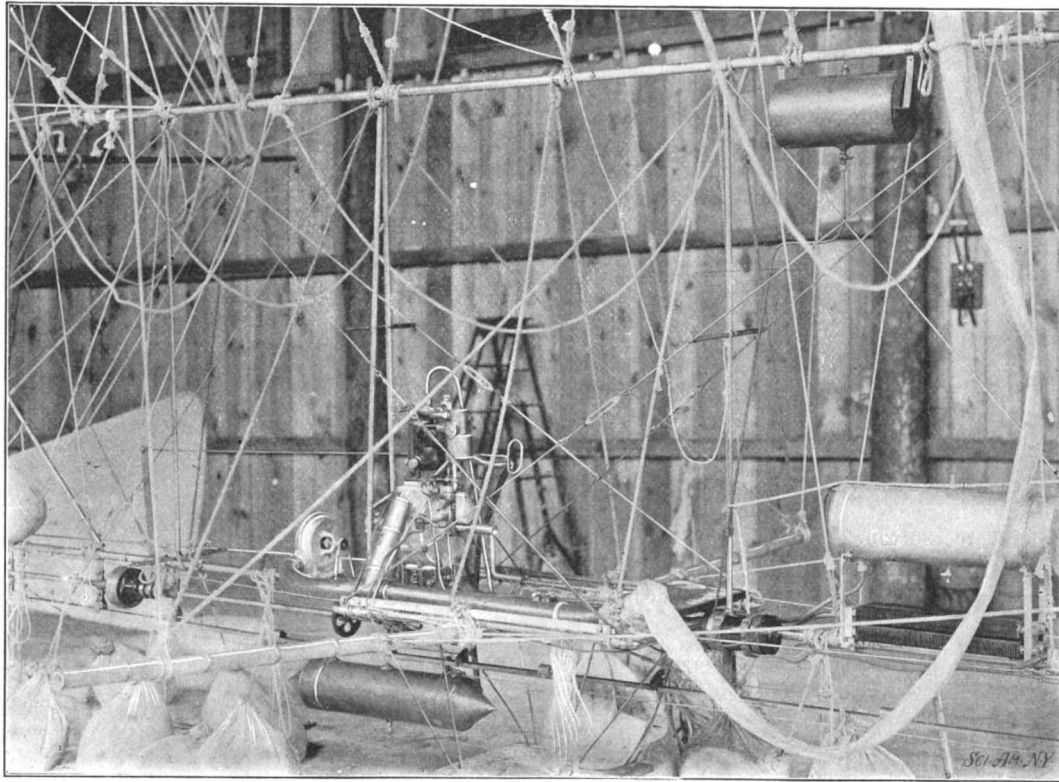

THE MOTOR AND THE SLIDING WEIGHT.

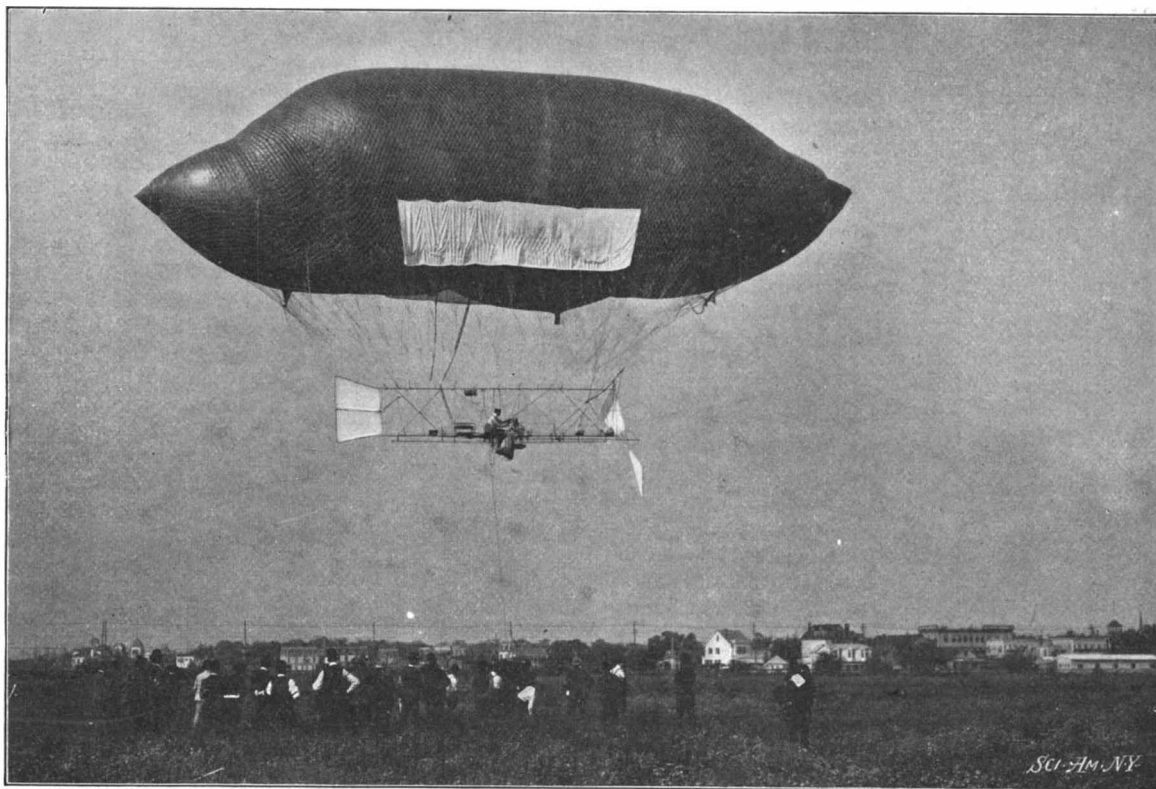

THE SECOND ASCENT OF STEVENS' AIRSHIP AT MANHATTAN BEACH.

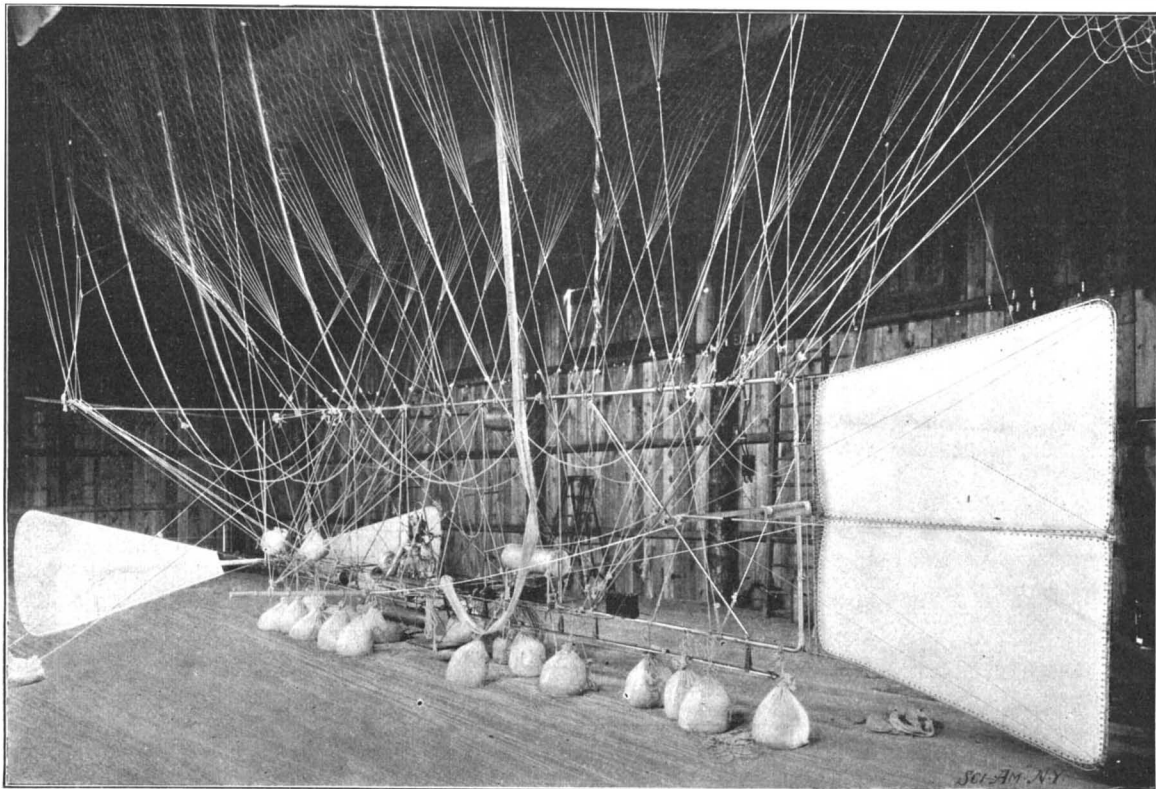

GENERAL VIEW OF THE FRAMEWORK.

#### STEVENS' AIRSHIP.

The number of aeronauts who are attacking the problem of aerial navigation by means of dirigible airships has been increased by the advent of Leo Stevens. Manhattan Beach has recently been the scene of two ascents made by him in a flying machine of his own design. It cannot be said that much has been achieved. Despite the inventor's indomitable confidence in his contrivance the tests thus far made have not been satisfactory. At no time was a free ascent made. In both the trials made the airship was held captive by a stout rope, and was not allowed to rise more than 150 feet above the ground.

The construction of Stevens' flying machine, although substantially following the lines laid down by previous aeronauts, nevertheless presents novel minor features that should prove of interest to investigators in the same field. The gas-bag is enclosed in an outer envelope, of the usual cigar shape, with ogival ends. The space between the gas-bag and outer envelope is filled with air by means of a blower driven from the motor. During the airship's flight the air is allowed to pass down again through the flexible tube by which the space was filled, to the motor, in order that it may cool the cylinders, the air being driven down through the tube by the expansion of the interior gas-bag.

At each side of the gas-bag envelope a canvas-covered frame is mounted to swing in a vertical direction. The lateral surfaces thus formed act together as a parachute. As the machine rises it is obvious that they will hang down from the envelope and will in no way retard either the ascent or backward and forward flight. When the airship descends the parachute surfaces will spread by reason of the air's resistance, and will thus retard the velocity of the descent.

The net surrounding the outer envelope is secured by cords to the upper member of a rectangular steel frame by which the motor, propeller, rudder and ballast are supported. From our illustration it will be seen that the motor is placed approximately in the middle of the frame, and that the aeronaut takes up his position immediately behind it.

The propeller is mounted at the bow; the rudder at the stern. It therefore follows that the flying machine is not driven from the rear, but is rather drawn along. Tiller ropes lead from the rudder to the aeronaut's seat.

Along the bottom of the rectangular frame a rail extends upon which a weight is arranged to slide. It is the purpose of this weight to keep the flying machine in proper longitudinal trim and to permit the aeronaut to change the direction of his flight vertically. A somewhat similar principle was employed by Von Zeppelin in his colossal airship. By moving the

weight to the bow the longitudinal axis of the airship will be inclined downwardly; by moving the weight to the stern the axis will be inclined in the opposite direction.

The envelope containing the gas-bag in this airship is 86 feet long and 22 feet in diameter, and has a capacity of 22,000 cubic feet of gas. The motor is of 7½ horse power. The two blades comprising the propeller have a total length of 16 feet and are 4 feet wide. The rudder is 7 feet high and 5 feet wide. Mr. Stevens estimates the lifting power of the balloon at 1,400 pounds. The weight of the machinery is about 700 pounds.

In the last experiment made the failure of the airship to fly was attributed to the defective operation of a clutch. A more pertinent reason can be found in the inadequate power of the motor. Seven and one-half horse power is hardly sufficient to drive a flying machine of such dimensions. If the lifting power of the balloon is 1,400 pounds, and the total weight of the driving machinery is but 700, there seems no reason why a heavier and more powerful motor cannot be used.

The detailed illustrations which we present herewith with picture the mechanical features clearly. The sliding weight previously referred to is the cylindrical object, pointed at either end, which figures in one of our illustrations. The fuel tank is secured to the top member of the rectangular frame.

#### The New Comet.

BY PROF. WILLIAM H. BROOKS, D.SC., F.R.A.S.

Comet B 1902, discovered by Mr. Perrine at the Lick Observatory on September 1, has been under observation at this observatory whenever conditions permitted.

For a few nights past the bright moonlight has effectually drowned out the light of the comet. This, however, was partially due to thick haze in connection with the moonlight. When the air was clear the comet could be seen in the ten-inch equatorial in the presence of a moon a day or two past the first quarter. When discovered the comet was of the ninth magnitude, but at my last observation it was much brighter than at discovery.

The comet's position at discovery was right ascension 3 h. 17 m. 49 s.; declination north 34 deg. 39 min. It was in the constellation Perseus, and about five degrees southeast of the star Algol, near which star it passed a few days later. The daily motion of the comet was about half a degree in a northwesterly direction.

The appearance of the comet was as follows: Slightly elongated head, tolerably well defined, nucleus, with a tail less than half a degree long.

The following parabolic elements have been computed by the discoverer:

Time of perihelion, November 23, 1902.  
Perihelion minus node, 153 deg. 25 min.  
Longitude of node, 49 deg. 56 min.  
Inclination, 156 deg. 54 min.  
Perihelion distance, 9.604.

The comet is slowly increasing in brightness and on October 5 it is computed to be twenty-seven times brighter than when discovered. From that time on the comet's light will slowly decrease, and at the time of perihelion it will be seventeen times brighter than at discovery.

On October 5, when the comet is at its greatest brilliancy, it will be in splendid position for observation, being about five degrees north of the star Alpha Cygni, and nearly pointed at by the upright beam in the cross of Cygnus.

The following ephemeris will show the path of the comet from that time to perihelion:

R. A.	Decl. North.
October 5—20 hours 56 min. + 50 deg. 20 min.	
October 22—17 hours 43 min.	3 deg. 53 min.
R. A.	Decl. South.
November 8—16 hours 57 min. — 11 deg. 00 min.	
November 23—16 hours 13 min.	18 deg. 13 min.

It will be seen that after October 5 the comet moves rapidly in a southwesterly course. On October 22 it is in the constellation Serpentarius near the right shoulder. On November 8 it is on the right knee of the same figure, having passed south of the celestial equator early in the month. On November 23, when the comet is in perihelion, it is in Scorpio and about eight degrees north of Antares.

Smith Observatory, Geneva, N. Y., September 19, 1902.

The new armored cruiser "Drake" recently steamed 24 knots an hour, which places her foremost among the swift cruisers of the navy of Great Britain. The "Drake" was launched at Pembroke in March of last year. Her displacement is 14,000 tons, her length 500 feet. Her armament consists of two 9.2-inch and twelve 6-inch guns, with the usual subsidiary weapons. The "Drake" is one of the "armored 'Powerful'" cruisers and was originally designed to steam 23 knots.

#### New Steam Automobile Records.

On September 24 the mile and five-mile records for steam vehicles were broken, by Mr. Charles Cannon, in the rather peculiar steam racer which he designed himself. The former records were held by Cannon. The new mile record of 1 minute 6¼ seconds, which he made was covered at Narragansett under conditions wholly out of keeping with those required for record-breaking attempts.

Alexander Winton in his "Bullet" also competed, but the high winds proved too much for his car. Winton covered 6 miles in 6 minutes 39 3-5 seconds, making 5 miles in 5 minutes 30 2-5 seconds. His fastest single mile was made in 1 minute 5 3-5 seconds.

Cannon's new record for 5 miles, made on the same occasion, is 6 minutes and 5 seconds. Cannon's former record was 6 minutes 43 1-5 seconds. How swift was the pace at Narragansett may be gathered from the fact that the slowest of Winton's first 5 miles was faster than any time made by Fournier last year. He covered the first mile in 1 minute 6½ seconds; the second in 1 minute 5¾ seconds; the third in 1 minute 6½ seconds; the fourth in 1 minute 6¼ seconds; and the fifth, the fastest, in 1 minute 5 3-5 seconds. Cannon's time by miles in his 5-mile record was 1 minute 12½ seconds, 2 minutes 26¾ seconds, 3 minutes 41½ seconds, 4 minutes 54 seconds and 6 minutes and 5 seconds. His time by quarters in the mile record was 0:16½, 0:33, 0:49½, 1:05¼.

#### The Government's Scientific Boarding House.

Dr. H. W. Wiley, Chief of the Division of Chemistry of the Department of Agriculture, will open in the autumn, under the authority of Congress, a kind of laboratory boarding house for the purpose of testing the effect of various preservatives, coloring matters, and food admixtures upon normal, healthy persons. The young men in the scientific bureaus of the Agricultural Department will be drawn upon first, and after them the resident college students of the city of Washington. Dr. Wiley intends to ascertain the relative harmfulness of various substances as a part of the movement toward pure food legislation. The effect of borax on foods has not been quite definitely determined. The German government contends that our borax-treated meats are harmful, although its own medical authorities oppose that view. Dr. Wiley contends that the small amount of boric acid used in curing meat is not harmful. His experiments will either substantiate or refute that belief. Each boarder is to keep a diary and record of all facts concerning himself. He is to eat only what is set before him, and, in accordance with Scriptural injunction, is to ask no questions, for the sake of his conscience, if not of his stomach. Every boarder will be weighed upon rising in the morning. His temperature will be taken. A careful account of the water consumed and of the food eaten will be kept. Since it would be difficult even for a hardened boarder to eat "doctored" food continuously, a "relaxation" diet of thoroughly pure food will be served half the time.

#### The Current Supplement.

Archæological matters have received unusual prominence in the current SUPPLEMENT, No. 1396. Hadrian's Villa at Tivoli is made the subject of a copiously illustrated article. Besides this description of a famous Roman Emperor's country seat, an explanation of how the Romans heated their living rooms and baths should prove of interest. In the allied science of ethnology, an article entitled "The Moros and their Country" will doubtless be welcomed. Mr. Hunziker's elaborate review of the existing methods of cultivating anaerobic bacteria is continued. One of the most important papers which has been published in the SUPPLEMENT for a long time is that of which the first installment appears in the present number. The paper in question is entitled "The History of Cold and the Absolute Zero," and comes from the pen of the noted physicist, Prof. James Dewar. Eugene C. Rost's entertaining account of Punta Arenas, the most southerly town on the globe, is most picturesque. Natural history is represented by an illustrated description of some animals in the Zoological Gardens in Berlin. The technologist has not been neglected. "The Testing of Cement" is the caption of a paper which will probably be of no little value to him. Some rather ingenious forms of electrically-operated air compressors are presented. A paper on acceleration tests of steam and electric trains made for the New York Central Road by Messrs. Arnold and Potter demonstrates how much more efficient electricity is than steam for tractive purposes.

The ostrich farming industry of Southern California represents an investment of three quarters of a million dollars, and the annual output of feathers is worth about \$100,000.

#### Automobile News.

Two recent novelties are found in a railway inspection car that has just been brought out by the De Dion Company in France, and an agricultural motor that has made some interesting exhibitions in England. The former weighs but 660 pounds, is fitted with a 3½ horse power motor, and is capable of carrying three persons as fast as 36 miles an hour. The operator is seated on a saddle back of a cross-seat arranged for inspection purposes. The Ivel agricultural motor, the invention of Mr. Dan Albone, of Biggleswade, is designed to draw anything from a wagon to a plow, and it can be used when stationary for grinding corn, etc., about the farm. It is propelled by a double cylinder, 8 horse power motor. When used for plowing the cost of fuel worked out at about 16 cents per acre.

Active preparations are being made for the Automobile Club of America's New York-Boston Reliability Trial on October 9. Seventy-two vehicles will probably participate in the run, and from present indications there will be about 66 per cent more gasoline than steam machines. The club has published a pamphlet containing road maps and explicit directions for following the course, which will be marked out with suitable arrow guideposts. A noteworthy feature of the arrangements is that no repairing of vehicles will be allowed at controls except such as can be done by local mechanics from 7 to 9 A. M. each day. All the other conditions of the run are such as to imitate as closely as possible those under which the ordinary tourist travels, and the test should give a clear indication of the reliability for long-distance travel of the various American automobiles.

Owing partly to the automobile and partly to the trolley car, the horse is rapidly disappearing from various large cities of Europe. Thus in Paris the total number of horses in 1901, according to a municipal census of these animals, was 96,698, while this year it is only 90,796, a falling off of about 6 per cent. In London in the same period the equine population has decreased 10 per cent, while in Berlin, Vienna and even in St. Petersburg the same falling off is to be noted. In the United States the supersession of the horse by the trolley car has been absolutely astonishing in its extent. Probably to-day in New York there are not more than two-thirds as many horses employed as were used twenty years ago. So far the automobile appears to have made no great inroads into the horse business, and it is likely that the extension of the use of automobiles will have to wait upon the growth of more scientific ideas regarding street paving and road making. However, the decadence of the horse is upon us, and his disappearance may be looked for sooner or later. On this point the Electrical Review ventures the opinion that the progress of engineering will develop methods that will totally extinguish the horse as a beast of burden.

The question of military automobiles in Russia is making some progress, and the Minister of War is to have experiments carried out during the coming grand maneuvers which are to be held near Koursk. Eight automobiles of French make are to be used, each having about 8 horse power. If the trials prove satisfactory there is no doubt that the use of the automobile will become general in the Russian army. One of the greatest obstacles to their successful use in that country is the bad condition of the roads. This was one of the drawbacks during a recent test which was made with a military automobile in the neighborhood of Warsaw, where but few of the roads were found practicable. In England military automobiles are making great progress. The War Office is so well pleased with their performance that it has recently formed a volunteer company of chauffeurs, chosen among the owners of vehicles, and the Military Transport Commission has followed their example. Since 1895 steam tractors have been frequently employed for military use, and during the war in South Africa and in the grand maneuvers of 1898 they were used quite extensively. The War Office, however, wished to improve on these results and opened a concourse for automobile transport wagons and tractors. This concourse took place last year, and among the competitors was an English vehicle which, after some slight modifications, seemed to fulfill the requirements. The War Office then detailed the officers and men of the transport section to enter the works in order to study the construction of the vehicle and the method of operating. It has been decided, besides, to form two special automobile corps. This will be a somewhat original move. Each of the corps will be made up of 162 officers and soldiers.

#### De la Vaulx's Failure to Cross the Mediterranean.

Comte de la Vaulx recently made a second attempt to cross the Mediterranean in his balloon. He made a favorable start from Palavas on the coast of France. Five aeronauts accompanied him. The balloon was driven ashore and descended at Capite, between Villerot and Les Salines.



**PREHISTORIC MEXICAN SIGN WRITING.**

BY JOHN G. ROTHERMEL.

The Duc de Loubat has recently placed all those interested in the various phases of human development under deep obligation, by having prepared in facsimile, at his own expense, the remarkable document known as the Codex Fejervary-Mayer.

This codex, which sheds much light upon the civilization of the ancient Nahuatl people, the linguistic group containing the Aztecs and other tribes, who inhabited that part of Central Mexico including the valley plateau Anahuac (country by the waters), the site of the present city of Mexico, which they founded, and the surrounding country, or according to Prescott, the territory comprised between lines drawn from the 18th and 21st degrees on the Gulf to the 14th and 19th on the Pacific, is one of the few of those curious pictorial writings which escaped destruction at the time of the Spanish conquest of the country. It is supposed that these productions, or at least those which related to state and religious matters, were always few in number and kept in the possession of the priests and higher officials, who alone understood and could interpret them. Those found by the conquerors, however, mostly fell a prey to the bigotry of the Spanish priests, so that but few copies ever reached Europe; and as many of these went into the hands of private parties, who regarded them as mere curios, most even of those that survived the priestly holocaust were eventually lost.

Another regrettable circumstance is that we have practically no means of working out correctly the evolutional phases of the religious concepts set forth in these documents, as they would no doubt acquaint us with a legend uniting the hieroglyphs, representing gods, nearly if not quite as numerous as those of Olympus, into a comprehensive whole. But as the pre-Columbian history of these Mexican races is shrouded in an impenetrable mist, we are almost restricted in our investigations to what can be deciphered from the codices themselves, in which one thing only is readily detectable, and that is that they are composed of pictures representing directly deities and objects in combination with characters having a symbolic meaning. Consequently all elucidations so far attempted have been more or less conjectural.

The Codex Fejervary-Mayer, of which we herewith

pointed on four strips of a kind of parchment made of deerskin, which are uniform in breadth, 6.8 inches, but of different lengths. These are pasted together, making a strip 12½ feet long, which is folded somewhat after the manner of a fan so as to make 22 leaves, each 6.8 inches square. Both sides of these are covered with a thin adhesive paste upon which the pic-

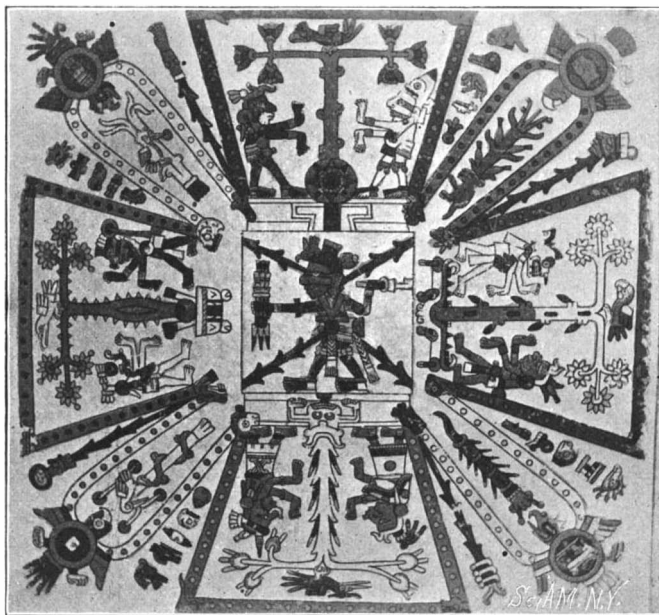

**The Five Regions of the World and Their Deities.**

tures are executed, the contours in deep black lines and the spaces in various colors.

According to Dr. Edward Seler, of the University of Berlin, to whom the Duc de Loubat referred it for elucidation, one side of the codex is devoted exclusively to the guardians of the night and other nocturnal eerie things, and the other to the guardians of the day. The first page of the night side he regards as being in a measure the key to the whole scheme. Here, he states, we see the world divided into five regions with the deities of each. In the center is the fire god, who is lord of the middle and the four cardinal points—east, north, west and south—as denoted by the four blood streams extending toward the corners, and continuing beyond the central square,

ters of the heavens, each being representative of the quarter symbolized by the horseshoe figure to its left. But in each of these trapeze figures there are depicted two other gods, making with the fire gods altogether nine deities who preside over the five regions of the world. These Dr. Seler takes to represent the guardian deities of the nine hours of the night, and to be the stone knife god, who is the god of human sacrifice, the sun god, the maize god, the death god, the goddess of flowing water, the goddess of dirt and sin, the heart of the mountain god and the rain god. The following pages 2 to 4 on this side of the document show these gods of night, embellished with various symbols, performing rites the significance of which it is difficult to make out. These are followed, pages 5 to 14, with what Dr. Seler describes as a "changed list of these gods," in which they are made to appear, according to his interpretation in other characters, associated with the middle and the four quarters: thus as the god of below and above, the god of the wind or thirteenth heaven, the god and goddess of flowers, pleasure and revelry, the goddess of song and dancing, the god and goddess of the house or night, etc. Throughout this series, he thinks there can be distinguished a foreboding significance intended to introduce the lords of night, the guardians of the five quarters, as the patrons of witchcraft. A very enigmatical series of these follow, which with pages 19 to 22 devoted to the gods of pleasure complete this side of the document.

The opposite side opens with what Dr. Seler calls "The Four Times Five Guardians of the Venus Periods," to which seven pages are devoted. The upper halves of these pages show gods in the act of performing human sacrifices, arranged in groups of five, of which there are four, while the lower halves exhibit gods in groups of two, to which the designation "The Gods of the Six Quarters" is applied. Both of these series he regards as being related to the four quarters, though in the latter gods of above and below are added. Succeeding these there are a series of pictures which the Doctor deciphers as having to do with a period of 59 days, but as being otherwise inexplicable. Then comes another lot which he refers to the guardians of the six quarters. These are followed by interesting congeries which he calls "The six heavenly wanderers," "The deities of the four

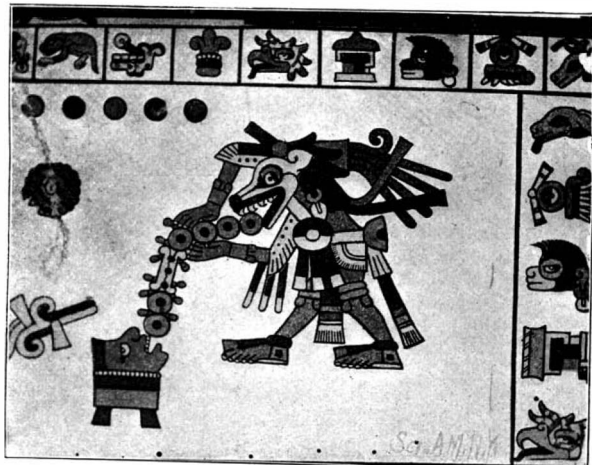

**The Demon of the Six Earthly Regions, Apparently feeding a Chain of Beads into a Human Head.**

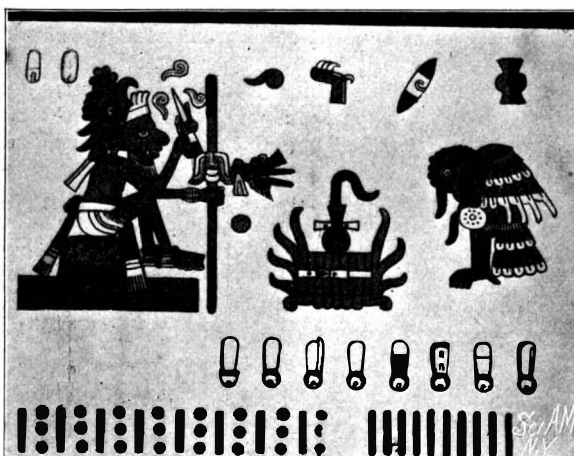

**The God of the 13th Heaven. Changed List of Guardians of the Five Regions of the World Series.**

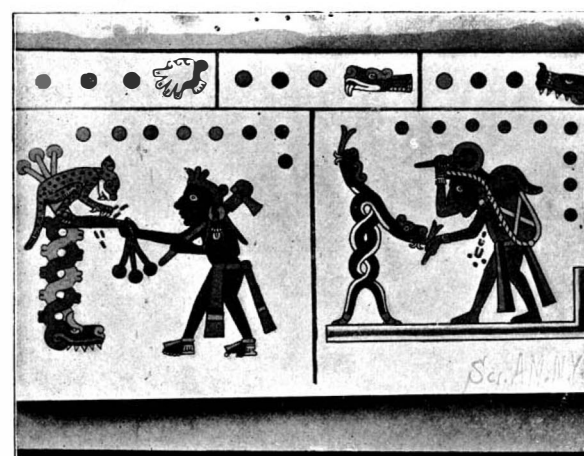

**Gods of the Period of 59 Days, performing Certain Rites.**



**The Demon of the Six Earthly Regions Series vanquishing an Enemy.**

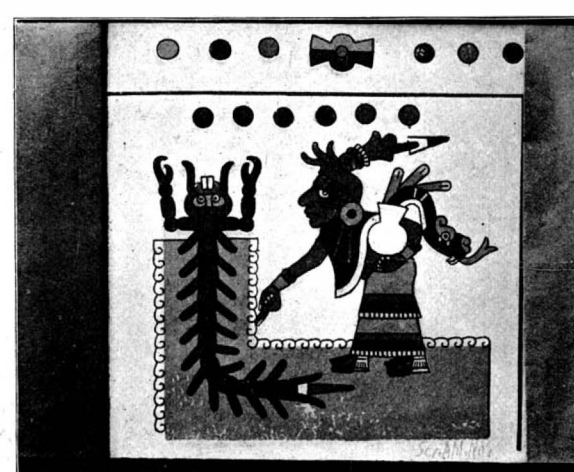

**Goddess of the Period of 59 Days, performing some Ceremony.**

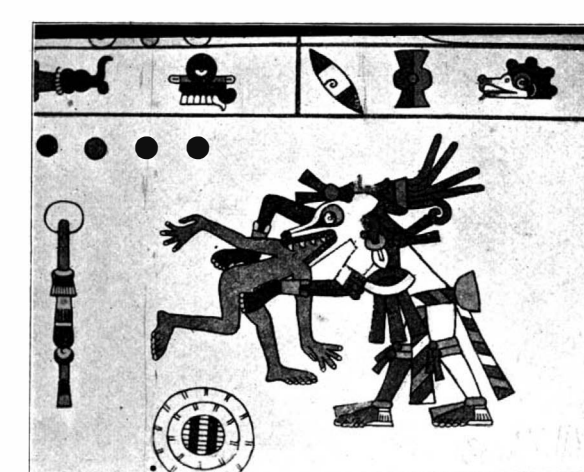

**The Demon of the Six Earthly Regions Series swallowing a Man.**

**PREHISTORIC MEXICAN SIGN WRITING.**

reproduce parts, appears to have had a checkered career. It takes its name from the celebrated Hungarian savant Gabriel Fejervary, to whom it at one time belonged, and was presented to the Liverpool Free Public Museum, where it now reposes, by one Joseph Mayer. Its history prior to the time it formed a part of Fejervary's collection is unknown. It is

where they are associated with designs symbolic of these points; that on the left-hand corner above representing the east; that on the left corner below, the north; that on the right corner below, the west; and that on the right corner above, the south. Similarly, on the four sides of the central square there are spaces divided off and allotted to the four quar-

cardinal points," "A second series of the gods of the four quarters," "The six heavens," "The six earthly regions," "The four forms of the deity of the planet Venus," and "Once more the five quarters." The whole concludes with a picture of Tezcatlipoca, the wizard.

This god, Dr. Seler explains, is the nocturnal, the mighty wandering god and the magician in a pre-em-

inent sense. He is here depicted surrounded by all the signs of the Tonalamatl—from *Tonal*, presiding genius of the day, and *mall*, book, the astrological calendar of this strange people, in which 13 x 20 = 260 days make the astrological year—by the signs which were held to be above all else alone decisive for the things occurring on consecutive days, for their good or bad luck and the tendencies inherent in them—signs which in themselves represent the tonalli, the fitness of the things taking place under their dates and forming the chief instruments in the hands of the seer, the soothsayer, the adviser of the people and the magician.

In this codex, together with the few others known, we have what is left of the records of a religious system or cult developed entirely distinct, and far differently from any of those known to history, pertaining to the most advanced people of the western world, those speaking the Nahuatl tongue, which, sad to relate, through the mistaken zeal of the white conquerors, has come down to us with such paucity of data as to make it doubtful whether ethnological students will ever be able to unravel its mysteries.

The codex contains about 130 figures of gods and goddesses surrounded with symbolic characters and performing various rites. The pictures alone are striking and interesting. How much more so would they be if we could solve their riddle.

#### THE TRUFFAULT RACER.

This machine, which, at first glance, seems extremely complicated, shows itself, when the operating mechanism is examined, to be constructed with the greatest simplicity. It can be summed up as follows: A motor, two pulleys, a belt, a lever, a steering arrangement and four wheels—without chains or gears—a single speed, and notwithstanding this, a variation in speed by means of the spark of from 6 to 60 miles an hour.

The frame, 3 feet wide by 6 in length, is constructed of 1¼ inch tubing 0.098 inch in thickness. The two pairs of wheels, which are quite small, are mounted so as not to track. The rear pair are mounted outside the frame in the usual manner and have a tread of 4 feet 3 inches, while the forward pair are set up in regular bicycle forks with a tread of 2 feet 5½ inches.

The seat of the operator is situated behind the rear axle on an extension of the frame and on a level with the same, which is 19½ inches from the ground. The driver therefore sits behind the rear wheels at a distance of 10½ feet from the extreme forward end of the machine, while the steering lever is 7 feet from the axles of the front wheels.

The motor is situated at a point exactly half way between the centers of the front and rear axles. The carbureter and the metal box inclosing the electrical apparatus are on the right side of the frame, between the motor and the seat. The gasoline tank is long and of a special shape, so as to offer the least air resistance possible. It is placed at the rear end of the machine to the left, below the frame. Just under the tank, and protected by it, is the belt.

The Buchet air cooled motor employed has two cylinders of 3.937-inch bore and 5.118-inch stroke. A 6¼-inch belt-pulley mounted on its shaft drives a 13¾-inch belt-pulley on the rear axle.

The frame is noteworthy in that it is suspended at the rear end from four jointed arms or brackets, bent at a sharp angle. Each of them terminates at one end in a cap and at the other in a steel pin which enters the tubing and compresses a strong coiled spring.

Steering is accomplished by a lever suitably connected with the front forks by a rod.

The machine is thrown in or out of gear and the speeds changed by a single lever acting on an idler pulley placed below the belt and tightening or loosening the latter by its pressure. In this way, viz., by the movement of the pulley, change of sparking, and admission of gas, all intermediate speeds between 6 and 60 miles an hour are obtained. The motor makes 166 revolutions per minute when the vehicle is traveling 6 miles an hour; 1,000 revolutions at 37¼ miles an hour, and 1,375 at 51½ miles an hour. The machine was officially tested at Deauville in the 600-mile race, where it attained the last-mentioned speed and won the first place.

It should be noted that the Truffault automobile has no differential. The inventor has dispensed with this by mounting the wheels on the back axles in a special manner, so that they can slip on it when the vehicle is rounding corners.

The machine we illustrate is an experimental model in which the inventor has tried to ease as much as possible the terrible shocks and jars so familiar to all those who have taken long trips in these rapid and light vehicles. It is to be hoped that this experimental type will, with some modifications, soon be-

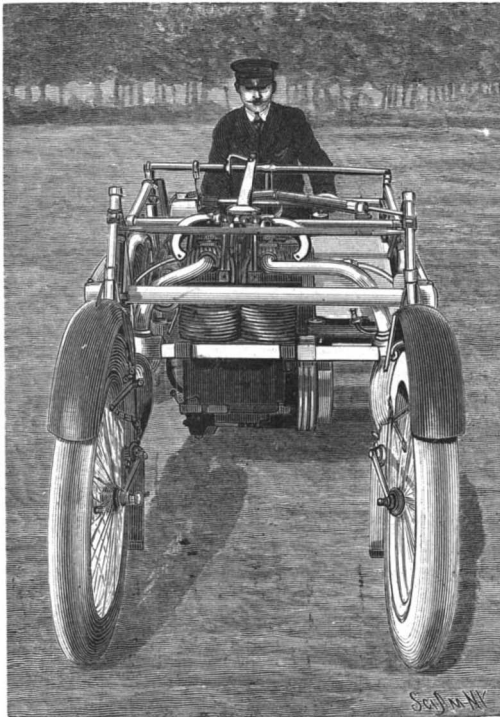

FRONT END OF TRUFFAULT RACER.

come an industrial one.—Translated for the SCIENTIFIC AMERICAN from La Locomotion.

#### Japan's Iron Industry.

For some years past the importance of rendering the Japanese government independent of foreign countries for a supply of iron and steel has attracted much attention in that country. In 1890 an attempt by the Naval Department to get a bill through the Diet for the establishment of iron and steel works for naval purposes was a failure. Soon afterward a commission was appointed to consider the matter, and especially to report "on the amount of iron ore obtainable in Japan, the trial manufacture of pig iron and steel, and the organization of the works." The commission sat for about five years, and after a trial manufacture of iron had been made the government resolved to establish works, and early in 1896 sub-

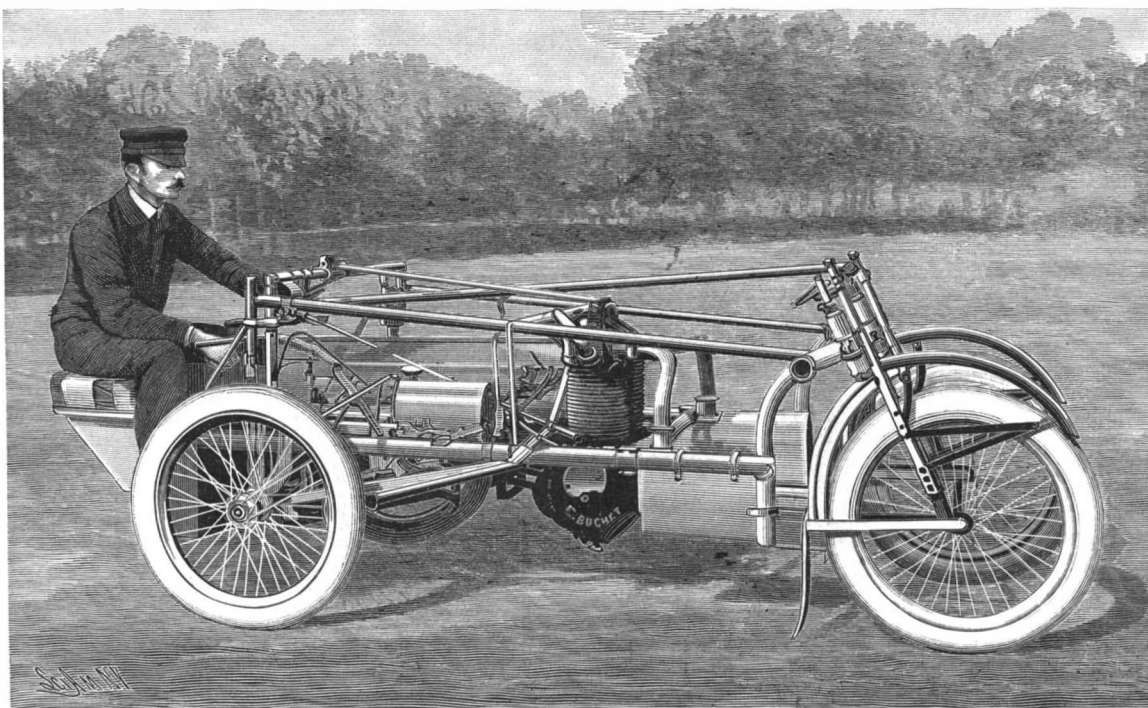

THE TRUFFAULT RACER.

mitted a bill to the Diet. They asked for an appropriation of over 4,000,000 yen (over £400,000) extending over four years, to construct works able to produce 60,000 tons of steel, which was about half the amount required at that time. This bill was unanimously passed into law, and Wakamatsu, in the northwest corner of the island of Kiu-shiu, near the open ports of Moji and Shimonoseki, was selected as the site of the works. Experts were dispatched to Europe and the United States to study the great iron and steel works there, and, as a result of their reports, further

appropriations, making in all 20,000,000 yen, were applied for and granted, and the Wakamatsu works were formally opened last October.

Mr. Ernest Griffiths, of the British consular service in Japan, has prepared an interesting report on them, which is appended to the annual report from Shimonoseki. Two foreign experts, both Germans, are employed. The works cover about 320 acres, and lie on the eastern side of a large lagoon, ten miles in circumference, which is connected with a pool or basin, a mile in diameter, and this again with the sea by a short and narrow channel. The lagoon is being deepened to 20 feet at ebb tide, and a quay over 2,000 feet long is being built along the front of the works, so that a ship of 3,000 tons displacement will be able to approach the quay wall. The work done up to the end of last year consisted of a channel 6,000 feet long, 240 feet wide, and 14 feet deep, extending from the sea to the pier of the Kiu-shiu Railway Company. The quay and all parts of the works are connected with the main line of this railway, and there are about 20 miles of line about the works. The raw material, consisting of magnetite, hematite and a smaller quantity of zimonite, is all obtained in Japan, except some supplied from Hupeh, in China. Two iron mines and three coal mines have been acquired for the use of the works, all within 20 miles of the latter and connected with them by rail.

It is estimated that when in full working order the establishment will require 250,000 tons of ore per annum, 380,000 tons of coke, and 800,000 tons of coal. It is said that when all the arrangements are complete, ore will be laid down in the works at a total cost of about five yen, or 10s. per ton. A recent official announcement states that the works are designed to supply the steel materials required by the government departments at a price to be arranged yearly in advance. Certain kinds of steel will be supplied to the public, but only in large quantities to Japanese engaged in industry, and at prices lower than the imported articles. In February last the production of pig iron began, and in May Siemens steel was produced at the rate of about 40 tons a day. Toward the end of June two of the five rolling mills were complete, and the production of medium and small rails and plates was started. The head of the works has stated that 90,000 to 100,000 tons of steel can be produced, and that the profits will cover, in a reasonable time, the capital invested in this important and novel industry in Japan. On the other hand, the British consul at Shimonoseki states that it is frequently said in the press that the works do not possess the confidence of the public and are not a success, and that representations have been made for their transfer to private hands at a nominal price.—London Times.

#### Big Oil Fleet.

A huge oil fleet will soon be engaged in transporting oil between New York, Philadelphia, Baltimore and Texas, consisting of twenty-five oil steamers having a carrying capacity of nearly 6,000 barrels. Besides this fleet there are also a large number of barges having almost the same carrying capacity. Apparently little Texas oil has found its way to New York, for the reason that it has been difficult to obtain vessels capable of carrying enormous quantities of oil. It is thought that the oil will find a ready market in the eastern ports of the United States. The cost of transportation to New York is estimated at 40 cents per barrel. How easily the oil can be handled is clearly shown by a striking example. The steamship "Roma" recently took on board a cargo in half a day; at her destination she discharged it in thirteen hours. The oil was taken aboard without the aid of stevedores, and was pumped for a distance of a mile from the vessel at her destination.

#### An Alaskan Oil Well.

An immense oil "gusher" has been struck at Cotella on the South Alaskan coast. The spouting oil rose nearly 200 feet before it could be capped. It is said that the oil is of good quality and is worth \$4 a barrel at the well. About 10 miles of coast line in the Cotella region have been located for oil borings. Some time ago an oil bed was discovered near the same place.



RECENTLY PATENTED INVENTIONS.

Agricultural Implements.

CORN-HARVESTER.—J. STRAND, Mankato, Kans. In this invention Mr. Strand aims to provide an instrument which when operated in a cornfield will receive the standing corn, snap the ears from the stalks and cut the husks of the ears as they leave the snapping device. The parts are so constructed and grouped that they can be used effectually in connection with husking devices including elevators.

SEED-PLANTER.—J. M. HIGBE, Manson, Iowa. In this seed-planter the dropping mechanism is driven by frictional gearing from the axle or other part connected with the traction wheels of the planter. The gearing comprises two independently operative trains, either one or both of which may be thrown into action as desired, the trains acting independently, to drive the dropping mechanism uniformly. The planted hills may be indicated by dropping on the ground from time to time a quantity of marking powder. Also a small plow may be used in front of each drive-wheel to clear away loose earth and afford a firm bearing for the wheels.

PLOW.—J. P. MULRONY, Plaza, Wash. This plow belongs to that class having cutters in disk-form for loosening the soil and severing weeds as the plow is progressively moved. Certain improvements are herein provided whereby the plow will more effectually excavate and loosen the soil, separate weeds, roots of plants, and other refuse growths therefrom, depositing the same on the surface of the plowed and pulverized soil.

Apparatus for Special Purposes.

TURPENTINE-STILL.—J. T. GILMER, Mobile, Ala. This apparatus is designed for use in the manufacture of rosin, turpentine, and like products. It comprises a gum vat and means for heating the same, a strainer in the upper part of the vat, and a funnel-like partition arranged below the strainer. A filter is situated in the mouth of this funnel-like partition, and the filter is formed of absorbent material sandwiched between screens or sieves.

ACETYLENE-GAS GENERATOR.—C. W. METCALF, Tucson, Arizona Ty. Mr. Metcalf has invented a new machine for generating gas from calcium carbide for illuminating or other purposes. The machine is practically automatic in its operation and is adapted to form a pure and clean gas.

PIPE-CLEANING APPARATUS.—E. D. CASE, Flint, Mich. This invention provides improved means for cleaning beer-distributing pipes or the like, in which the cleaning solution may be at all times ready for instant use. The solution is forced into the pipe or pipes by its own pressure, thus obviating the use of pumps, heating devices, or water pressure.

Electrical Devices.

LEAD FUSE FOR ELECTRIC CIRCUITS.—F. H. KREBS, Romersgade 3, Copenhagen, Denmark. The object of this invention is to do away with the metal lining in fuse plugs for electrical construction, thus cheapening the manufacture. The fuse plugs are so constructed that they may be easily repaired when the wire is melted through. Heretofore when the wire has been melted, new plugs have generally been used, the repairing of the old plug being almost as expensive as procuring a new one.

Mechanical Devices.

MACHINE-GUN.—E. M. CAPPS, San Diego, Cal. This invention relates to machine guns of that class in which a flat series of barrels disposed side by side in a suitable frame are arranged to be reciprocated longitudinally, so as to cause their open breech ends to alternately telescope over a corresponding series of cartridges while the latter are being fired and then advance sufficiently to allow the empty shells to drop, the mechanism for feeding the cartridge exploding the same and reciprocating the battery of the gun barrels being all operated by a crank under control of the gunner. Various important improvements are provided in this invention.

LOCKING DEVICE.—J. W. GONCE, Kinderhook, Ala. The invention relates to improvements in what is termed "ball-and-socket" locking devices that may be employed for a variety of purposes—such, for instance, as for vehicle brakes, shaft couplings, car-couplings, driving gear for mowers, locks, etc.

POWER MECHANISM.—F. CLEMENS, Jr., Delta, Iowa. Mr. Clemens has invented an improved mechanism for transforming and transmitting power. It is particularly adapted to be driven by horse or other animal power and may be used with advantageous results for pumping water, sawing wood and various other domestic purposes.

COMBINED PRESSER-FOOT AND NEEDLE-BAR LIFTING MECHANISM FOR SEWING-MACHINES.—E. O'DONNELL, Fall River, Mass. Improvements are provided in this invention whereby the upward movement of the presser-foot and needle-bar will be disconnected from the driving mechanism and lifted to a height sufficient to bring the point of the needle above the bottom of the presser-foot when the latter is at its highest position. The advantage of this is that there is no

danger of breaking the needle when material of stiff or cumbersome nature is being placed under the presser-foot, because it is impossible to accidentally start the needle, since when the needle is thus raised it is disconnected from the driving shaft.

FIRE-ESCAPE.—M. WACHTER, Trenton, N. J. This simple and economic form of fire escape comprises a pulley or drum, a support for the same, an endless rope or chain carried by the pulley or drum, and a brake arranged to automatically control the speed of the pulley or drum, thus causing the rope or chain to travel at a slow and safe speed, irrespective of the weight carried.

SURVEYING INSTRUMENT.—T. H. FERGUSON, Soochow, near Shanghai, China. By this invention Mr. Ferguson provides an improved instrument for measuring and automatically recording the distance traveled by a person, animal or vehicle, and the direction or directions of the route taken.

Railway Contrivances.

GRAIN-CAR DOOR.—A. L. HOOK, Coffeyville, Kans. The invention relates to doors for grain-cars and appertains to doors of this character held in slideways and adapted to be lifted therein with suitable mechanism supported above the door, and also adapted to be raised above the slideways and swung up to the top of the car, where they may be supported by a hook or other device.

STATION-INDICATOR.—J. S. ANDERSON, Brooklyn, N. Y. This device is adapted to indicate the stations or stopping-points of railway cars. It is particularly adapted for use in connection with street-railways to indicate the crossing streets, although obviously it may be applied to other railways.

Vehicle Accessories.

VEHICLE-SEAT BRACE.—G. W. VINSON, Paducah, Ky. An improved brace for supporting the seat and body of any vehicle is provided by this invention. In some types of vehicles the seat structure is commonly employed as the sole means for supporting the vehicle-top, and for such construction this invention will be found particularly useful.

FRAME FOR MOTOR-BICYCLES.—G. WAGNER and B. B. BIRD, St. Paul, Minn. The frame is arranged to carry the motor in a loop immediately back of the front wheel and below the center of the wheels within a short distance of the ground. The weight of the motor is thus equally distributed between the wheels and permits easy steering of the machine, at the same time protecting the rider from the oil and heat of the motor.

BICYCLE-PEDAL.—J. A. DECUR, New Orleans, La. This bicycle pedal combines the maximum lightness, strength, durability and cheapness. The invention is embodied in the peculiar construction of hubs adapted to rotate upon the spindle of the crank, and the manner of attachment to the hubs of toothed frames or frame-sections constituting foot-holds.

Miscellaneous.

FOLDING STRETCHER OR COT.—J. H. KOONS, Lehighton, Pa. This stretcher is simple and durable in construction and may be easily set up with the parts securely locked against accidental closing. It is adapted to be folded into a comparatively small space for storing or transportation purposes.

STEAM-GENERATOR.—P. STOLTZ, 138 Friedrichstrasse, Berlin, Germany. The invention relates to steam-generators having several groups of tubes connected together, whereby the adjacently disposed longitudinal tubes and the cross passages for connecting the ends of the latter with each other in each group of tubes form an undivided structure.

ASH-SIFTER.—E. WILLCOX, Yonkers, N. Y. This ash-sifter is adapted for ordinary or household use, or it may be made on a larger scale for use in large buildings. The device comprises few working parts which are efficient in operation and not liable to get out of order.

WALL WATER-HEATER.—J. H. MACKLEY, Pocatello, Idaho. Mr. Mackley has in this invention provided a novel construction of heater which can be readily supported against the wall in convenient position for use and connected with a water supply in such manner as to secure a circulation of the water through the heater.

CONSTRUCTION OF TANKS.—E. D. CHESTER, 120 Bishopgate Street Within London, England. The invention relates to a construction of tanks particularly such as are intended for use in cyanide or other solvent treatments of ores. By this improved method the tank may be more easily and expeditiously erected than other similar tanks heretofore used.

SHOVEL-SUPPORT.—J. BAKER, Carroll, Neb. This shovel support is designed to materially assist workmen in raising and delivering material operated upon. The principal object of the invention is to yieldingly support a shovel in such a manner as to relieve the workman of a portion of the burden of lifting the shovel and contents, also to enable the workman in stooping to bear a portion of his weight upon the shovel or support thereof.

SAMPLE CASE AND EXHIBITOR.—SAMUEL M. WIXCEL, Marcus, Iowa. Mr. Wixel is the inventor of an improved sample display case which is adapted for holding and exhibiting wall paper samples. Three exhibitor sections are provided, adapted respectively, to carry a sample of the wall, border, and ceiling patterns, and combined with each other in such a manner as to enable them to be readily and effectively folded into a case provided for the purpose.

NOTE.—Copies of any of these patents will be furnished by Munn & Co. for ten cents each. Please state the name of the patentee, title of the invention, and date of this paper.

Business and Personal Wants.

READ THIS COLUMN CAREFULLY.—You will find inquiries for certain classes of articles numbered in consecutive order. If you manufacture these goods write us at once and we will send you the name and address of the party desiring the information. In every case it is necessary to give the number of the inquiry.

MUNN & CO.

Marine Iron Works, Chicago. Catalogue free.

Inquiry No. 3203.—For makers of farming machinery.

AUTOS.—Duryea Power Co., Reading, Pa.

Inquiry No. 3204.—For an irrigation pump with a light machine.

“U. S.” Metal Polish, Indianapolis. Samples free.

Inquiry No. 3205.—For ten light carts to load about 12 to 15 cwt.

For bridge erecting engines, J. S. Mundy, Newark, N. J.

Inquiry No. 3206.—For makers of light, malleable castings.

Handle & Spoke Mchy. Ober Mfg. Co., 10 Bell St., Chagrin Falls, O.

Inquiry No. 3207.—For manufacturers of small capacity ice machines.

Sawmill machinery and outfits manufactured by the Lane Mfg. Co., Box 13, Montpelier, Vt.

Inquiry No. 3208.—For makers of twist drills.

WANTED A PATENT.—To purchase or on royalty. W. S. Chamberlin, 718 Avenue D, Bayonne, N. J.

Inquiry No. 3209.—For a complete set of tools for punching, stamping, perforating, polishing small metal buttons.

Die work, experimental work and novelties manufactured. American Hardware Mfg. Co., Ottawa, Ill.

Inquiry No. 3210.—For makers of substitutes for hard rubber.

Book “Dies and Diemaking,” 100 6x9 pages, \$1, post-paid. Send for index. J. L. Lucas, Bridgeport, Conn.

Inquiry No. 3211.—For information as to the manufacture of telephone receiver shells and moulds for same.

FOR SALE.—Patented novelty Nos. 678,945 and 691,364. For further information address P. O. Box 51, Downingtown, Pa.

Inquiry No. 3212.—For a rug-fringing machine which works like a sewing machine.

Inventions developed and perfected. Designing and machine work. Garvin Machine Co., 149 Varick, cor. Spring Sts., N. Y.

Inquiry No. 3213.—For makers of games and Christmas novelties.

Manufacturers of patent articles, dies, stamping tools, light machinery. Quadriga Manufacturing Company, 18 South Canal Street, Chicago.

Inquiry No. 3214.—For spring motors as are used in large machines.

Clippings of everything printed on any subject in the American and foreign press. United States Press Clipping Bureau 153 LaSalle Street, Chicago, Ill.

Inquiry No. 3215.—For makers of automobile and gasoline engine castings.

The largest manufacturer in the world of merry-go-rounds, shooting galleries and hand organs. For prices and terms write to C. W. Parker, Abilene, Kan.

Inquiry No. 3216.—For machinery for making cords and tassels.

The celebrated “Hornsby-Akroyd” Patent Safety Oil Engine is built by the De La Vergne Refrigerating Machine Company. Foot of East 138th Street, New York.

Inquiry No. 3217.—For makers of hot air furnaces.

The best book for electricians and beginners in electricity is “Experimental Science,” by Geo. M. Hopkins. By mail, \$5. Munn & Co., publishers, 361 Broadway, N. Y.

Inquiry No. 3218.—For makers of novelties and useful articles for the mail order business.

WANTED.—Two machinists accustomed to steam engine work, Corliss and Buckeye preferred; one millwright. Only steady men need apply. Hartford Engine Works, Hartford, Conn.

Inquiry No. 3219.—For firms dealing in advertising, household, hotel, toy or railroad novelties.

FOR SALE.—Patent for a rotary pump or exclusive manufacturing rights. Superior to any now manufactured. Circular sent on application to Wm. H. Slade, 5 Austin Building, Buffalo, N. Y.

Inquiry No. 3220.—For the makers of the “Loki” oil burner for ranges.

Special tools, models, fine light machinery, experimental and electrical work wanted, also specialties to manufacture. The General Manufacturing Company, 40 West 13th Street, New York City.

Inquiry No. 3221.—For a small steam turbine of 1 to 2 1/2 h. p. for experimental purposes.

Send for new and complete catalogue of Scientific and other Books for sale by Munn & Co., 361 Broadway, New York. Free on application.

Inquiry No. 3222.—For makers of glass paper weights for advertising purposes, with advertisement underneath.

Inquiry No. 3223.—For beaded elbows and beaded T's, said to be manufactured by H. Munzing.

Inquiry No. 3224.—For manufacturers of malleable iron who can furnish parts of the Covert snap in quantity.

Inquiry No. 3225.—For a power or hand machine for weaving wire fence.

Inquiry No. 3226.—For machinery for making pearl buttons.

Inquiry No. 3227.—For a small, strong machine for grinding rice into flour.

INDEX OF INVENTIONS

For which Letters Patent of the United States were Issued for the Week Ending

September 23, 1902,

AND EACH BEARING THAT DATE.

[See note at end of list about copies of these patents.]

Table listing inventions with names of inventors and patent numbers. Includes items like Accordion, Adding machine, Adhesive, Advertising device, Air compressing apparatus, Air compressor, Air cooling and filtering apparatus, Alloys of the alkali metals, Ammonia generator, Ammunition from the ammunition carriage, Arch construction, Automobile steering device, Axle spindle take-up device, Bandage, Bath, Batteries, Beam clamp, Bean separator, Bearing, axle, Bearing, spindle, Bodstead, metal, Beer, apparatus for cleaning cellular tissues, Beer, manufacturing non-alcoholic, Beet topper, M. W. Palmer, Bevel, D. E. Hughes, Bicycle, C. H. Ocumpaugh, Bicycle, chainless, Bicycle frame, Blowpipe, gas, Boards, machine for forming blanks from, Boiler furnace, Boiler tube cutter, Book cover, memorandum, Book leaf, Bookbinding sheet, Bookkeeping, Bottle rinser, Colby & Heinsdorf, Bottle stopper, Bowling alley, Box or carton blanks, mechanism for removing selvage from, Brander, electric, Jenkins & Rohmann, Bread cutter, W. O. N. Morrison, Bridle bit, C. W. Brown, Brooder, chicken, N. Pedersen, Brush, J. Schreiner, Buggy boot, J. W. Simmons, Button, wire, S. A. Foster, Camera, folding stereoscopic, Camera stand, adjustable, Cane, magazine torpedo, Cans, measuring and discharging apparatus for filling, Car axles, means for driving generators by power taken from, Car center bearing, railway, Car coupling, A. B. Carter, Car coupling, Seamor & Kepple, Car end panel and seat post, open, Car grain door, L. A. Hoerr, Car haul, A. M. Acklin, Car mover, Harrington & Towers, Car seat ticket holder, G. H. Roberts, Sr., Car seats and seat post with which it connects, end panel for open, Car, stock, W. Cline, Car uncoupling means, G. Groobey, Car uncoupling mechanism, railway, Groobey & Bush, Cars, pivoted rocker bearing center plate for railway, Carborundum articles and making same, Carbureter, A. M. Rosenberry, Carburetor, J. Forde, Cart or wagon, dumping, Case: See Coin case, Casting pig metal, mold coating for apparatus for, Cement, adhesive, Change making machine, Check perforating machine, Check perforator, Checkrein book, Chenille spotting machine, Churn, A. Mitchell, Chute, adjustable loading, Cigarette machines, device for feeding tobacco in, Clasp or fastener, N. Crane, Clock, electric, Clock pendulum regulator, Clothes wringer, Clutch, P. A. Houghtaling, Clutch operating mechanism, Coaster brake, Coconut cutting machine, Coin case, B. Anderson, Compasses, Concentrator, Holmes & Wood, Conduit rod, coupling, Conveyer, M. Bradford, Cooking cabinet, H. Faschian, Cork fastener, R. Blezinger, Corset stiffener, H. Torley, Crate, folding, Heller & Jones, Creel for selvage spools on slashers, Curtain fixture and curtain support, combined, Cycle motor attachment, Cycle rest, H. U. von Trotschke, Dental gage, C. R. Vanderpool, Dental mouth mirror, Bennett & Thatcher, Dice cup, H. L. Haskell, Display box, B. Budweiser, Drafting plotter, R. L. Botts, Draw-off or stretching rollers for textile machinery, A. Bietenholz, Dredge, mining, Barton & La Bud, Drying chambers, apparatus for carrying goods through, Drill: See Grain drill, Drill press, A. Vlk, Dynamo and driving gear, combined, Eggs, preserving, Electric wire pole, Electrical indicator, Electrical translating devices, controlling the energy delivered to, Elevator, Baldwin & Green, Elevator safety device, A. W. Leach, Enameled metal plates, manufacture of, Engines, electric igniter for explosive, Envelope, Stearns & Weber, Eraser, blackboard, F. C. Raber, Eyeglasses, R. B. Finch, Eyeglasses, E. H. Schild, Feather fabric, woven, Warren & Holden, Fence post, C. O. Blee and J. H. Redding, Fence post, I. M. Warner, Fence post, metallic, J. A. Utter, Fences, machine for weaving cross wires in, Groves & O'Day, File, G. H. Kravik, File for papers and documents, Schmidmer

(Continued on page 228)





**Our Pen-Carbon Letter Book** **Copies Letters While You Write**

Use your own paper. Any pen, any ink, no press

**Government Officials, Colonists, Farmers, will find it invaluable.**

Every man who writes letters should write for price if his stationer does, but keep it. We manufacture "Ditmars" Typewriter Ribbons and Carbon Paper.

**PEN-CARBON MANIFOLD CO., Dept. 1, 145-7-9 Centre St., New York, U.S.A.**

**AUTOMOBILE Parts and Castings**

We sell castings of Gasoline Engines 1 to 12 H. P.

They are fine for Boat Engines also. Auto Supplies. Get our Catalog—500 illus.

**A. L. DYKE,**  
Vandeventer & Washington Aves., St. Louis, Mo.

**The "Wolverine" Three Cylinder Gasoline Marine Engine.**

The only reversing and self-starting gasoline engine on the market. Lightest engine for the power built. Practically no vibration. Absolutely safe. Single, double and triple marine and stationary motors from 2 to 30 H. P.

**WOLVERINE MOTOR WORKS,**  
Grand Rapids, Mich.

**Howard Two and Four Cycle Marine and Automobile Motors**

Write for Cat. Grant Ferris Co. Troy, N. Y.

**WORKS LIKE A CHARM.**

Perfect satisfaction is experienced using our No. 8 or 9 Hand Pipe Threading and Cutting Machines. Crank or ratchet power. Gears housed from dust. Chasers set by graduation to any size, can be released from threading while in motion, opened to permit pipe being cut, and instantly closed.

Send for Free Catalogue to **The Merrell Manufacturing Co., 501 Curtiss Street, Toledo, Ohio.**

**BRENNAN GASOLINE MOTORS**

Of the highest efficiency and latest approved pattern. They are safe, sure, smooth running and quick to start. Ensure economy of fuel and are free from vibration. Built on the four-cycle principle and have great durability. In two distinct types—horizontal for automobiles and vertical for automobiles and boats.

**BRENNAN MFG. CO., Syracuse, N.Y., U.S.A.**

**The Franklin Gas Engine**

One-Half Horse Power worth \$100 complete. We sell all necessary castings, materials and detail drawings for \$16.50. For real work—not a toy. 450 revolutions per minute. Upright or horizontal form. Finished parts sold separately. Runs by gas or gasoline. For boys and men with a mechanical turn. Write for circular.

**PARSELL & WEED,**  
129-131 West 31st St., New York.

**TOOLS OF ALL KINDS**

GOODNOW-NIGHTMAN BOSTON

Removed to 182 Milk Street.

**THE WATERBURY Emery Grinder,**

with adjustable table, for flat surface grinding and finishing, and for ordinary tool grinding.

Send for Catalogue.

**BLAKE & JOHNSON**  
P. O. BOX 7,  
WATERBURY, CONN.

**JUST PUBLISHED**

**Practical Pointers For Patentees**

Containing Valuable Information and Advice on **THE SALE OF PATENTS.**

An Elucidation of the Best Methods Employed by the Most Successful Inventors in Handling Their Inventions.

By **F. A. CRESEE, M. E.**

144 Pages. Cloth. Price, \$1.00.

**THIS** is the most practical, up-to-date book published in the interest of Patentees, setting forth the best methods employed by the most successful inventors in handling their patents. It is written expressly for Patentees by a practical inventor, and is based upon the experience of some of the most successful inventors of the day.

It gives exactly that information and advice about handling patents that should be possessed by every inventor who would achieve success by his ingenuity, and will save the cost of many expensive experiments as well as much valuable time in realizing from your inventions. It contains no advertisements of any description and is published in the interests of the Patentee alone, and its only object is to give him such practical information and advice as will enable him to intelligently handle his patent successfully, economically and profitably.

It gives a vast amount of valuable information along this line that can only be acquired by long, expensive experience in realizing from the monopoly afforded by a patent.

Send for Descriptive Circular.

**MUNN & CO.,**  
Publishers, 361 Broadway, New York.

Packing house products, certain named, Schwarzschild & Sulzberger Co. 38,929 to 38,932

Painters' supplies, certain named, Universal Paint-Solvent Co. 38,936

Pencil sharpeners, Eagle Penell Co. 38,902

Pens, C. Howard Hunt Pen Co. 38,901

Remedial agent, certain named, Maibrunn & Knappe 38,918

Remedies in tablet form for certain named diseases, B. N. Robinson 38,919

Shirtwaists and skirts, Gottlieb & Beck 38,904

Shirts, collars and cuffs, H. Dobson 38,903

Shoes, men's, boys' and youths', B. A. Corbin & Son Co. 38,912

Silks, Consumers' Silk Mills and Coupons Exchange Co. 38,906

Skylights, A. E. Rendle 38,941

Soap, Goodhair Remedy Co. 38,915

Tonic for the bladder and kidneys, A. Spiegel Co. 38,917

Wall finishing and decorating material, Muralo Company 38,939

Wines, port and sherry, G. G. Sandeman Sons & Co. 38,924

**LABELS.**

"Cameo Hair Food," for hair food, Cameo Chemical Co. 9,448

"Canastota's Best 5c. Cigar," for cigars, De-tor Bros. 9,442

"Chesterfield Splits," for aperient water, Swineford's Arsenic-Lithia Water Co. 9,445

"Dr. A. L. Schmidt's 'U-Go' Blood Purifier Rheumatic Sore," for a medicine, F. T. Schmidt & Sons 9,449

"E. Poncelet Freres," for creme de menthe, J. Clavel Wine & Cordial Co. 9,444

"Maryland Leader," for canned peaches, Phillips Packing Co. 9,447

"Mexjoja Coffee," for coffee, Arbuckle Bros. 9,446

"Mi Todo," for cigars, M. Fernandez 9,443

A printed copy of the specification and drawing of any patent in the foregoing list, or any patent in print issued since 1863, will be furnished from this office for 10 cents, provided the name and number of the patent desired and the date be given. Address Munn & Co., 361 Broadway, New York.

Canadian patents may now be obtained by the inventors for any of the inventions named in the foregoing list. For terms and further particulars address Munn & Co., 361 Broadway, New York.

**NEW BOOKS, ETC.**

**THE ENCYCLOPEDIA OF CERAMICS.** Compiled by W. P. Jervis. With Much Original Matter Now First Published. New York: Blanchard. 1902. Pp. 673. Price \$6.50.

Mr. Jervis has succeeded in producing a most handsome volume on a subject which has, perhaps, been hitherto best treated in European books. The value of his work as a reference book can be determined only by fairly long use. The examination which we have given the work convinces us that it is one which should find a place in the library of every ceramic artist. Its scope is wide, its treatment sufficiently minute for an encyclopedia, and its trustworthiness above reproach.

**NEW YORK STATE LIBRARY. Bulletin 72.** Albany: University of the State of New York. March, 1902. Pp. 248. Price 25c.

**BULLETIN OF THE AGRICULTURAL EXPERIMENT STATION OF THE UNIVERSITY OF TENNESSEE. Vol. XV. April, 1902.**—The Action of Copper on Leaves.—With special reference to the injurious effects of fungicides on peach foliage. A Physiological Investigation. Knoxville, Tenn. Pp. 108.

**THE JOURNAL OF THE DEPARTMENT OF AGRICULTURE OF VICTORIA.** Published for and on Behalf of the Government by Direction of the Hon. John Morrissey, M.L.A. Edited by H. W. Potts, F.C.S., F.L.S. 1902. Pp. 115-219.

**THIRTY-THIRD ANNUAL REPORT OF THE SECRETARY OF STATE ON THE REGISTRATION OF BIRTHS AND DEATHS, MARRIAGES AND DIVORCES IN MICHIGAN FOR THE YEAR 1899.** Fred M. Warner, Secretary of State. Edited by Cressly L. Wilbur, M.D. 1902. Pp. 157.

**SIXTEENTH ANNUAL REPORT OF THE COMMISSIONER OF LABOR, 1901.** Strikes and Lockouts. Washington: Government Printing Office. 1901. Pp. 1,053.

**THE PRINCIPLES OF CHESS IN THEORY AND PRACTICE.** By James Mason. London: Horace Cox. 1902. 16mo. Pp. vii., 330.

**L'ETERE E LA MATERIA PONDERABILE. Teoria Meccanica dei Principali Fenomeni Fisici.** Torino: Tip. e Lit. Camilla e Bertolero di N. Bertolero. 1902. Pp. 133.

**REPORT OF THE COMMISSIONERS APPOINTED TO REVISE THE STATUTES RELATING TO PATENTS, TRADE AND OTHER MARKS, AND TRADE AND COMMERCIAL NAMES.** Under Act of Congress Approved June 4, 1898. Francis Forbes, Peter Stenger Grosscup and Arthur P. Greely, Commissioners. Washington: Government Printing Office. 1902. Pp. 549.

**NOTES OF A TRIP TO THE VEDDAHS OF CEYLON.** By Dr. H. M. Miller and Dr. W. H. Furness. Pp. 44.

**METEOROLOGICAL OBSERVATORY AND OTHER PLACES IN SOUTH AUSTRALIA AND THE NORTHERN TERRITORY DURING THE YEAR 1898.** Under the Direction of Charles Todd, K.C.M.G., M.A., F.R.S., F.R.A.S., F.R.M.S., M.I.E.E., Government Astronomer, Postmaster-General and Superintendent of Telegraphs. Published by Authority of

(Continued on page 230)

**The MAN and the HOUR meet by the time of an Elgin Watch**

Punctuality's watch word is *Elgin*. Worn everywhere; sold everywhere; guaranteed by the world's greatest watch factory. Booklet mailed free.

**ELGIN NATIONAL WATCH CO.,**  
ELGIN, ILLINOIS.

**"D. and J." HANGERS** are **Absolutely the BEST.** WHY?

They are Mechanically Correct, Accurately Ground, Lightest, Nearest Dust and Water-Proof, Neatest in appearance, and they are used by the best Manufacturers and ridden by the best Professionals and Amateurs of America.

**Park City Mfg. Co., Inc., Chicago.**

**BEST REPEATING SHOT GUN ONLY \$15.75**

Sportsman write: "Spencer best gun in the world." No more after present lot sold. Original slide lever gun made of best forged steel, fast figured twist steel barrel. Double extractors. Take down system. Six shots in 2 seconds. Strongest repeater made. Send \$5; gun sent C. O. D., balance \$10.75 and express; examination allowed. **F. B. Benson, 579 Broadway, N.Y.**

**SIGNALING THROUGH SPACE** without wires.—An article by W. Preece, describing the new Marconi system of telegraphing without wires. 6 illustrations. **SCIENTIFIC AMERICAN SUPPLEMENT 1124.** Price 10 cents. For sale by Munn & Co. and all newsdealers.

**Apple Economical Gas Engine Igniters**

Are positively the best built for Stationary, Automobile and Marine Gas Engines, either touch or jump spark system. We are the leaders in the manufacture of Igniting Dynamos, Magnets, Governors, Coils, Plugs, etc. Write for printed matter. **The Dayton Electrical Manufacturing Company,** No. 87 South St. Clair St., Dayton, Ohio, U. S. A.

New York stock carried by Chas. E. Miller, 97 Reade Street, N. Y.; Philadelphia Office, The Bourse; Chicago Office, 19-21 La Salle Street; St. Louis stock carried by A. L. Dyke, Linnar Building; Boston Stock carried by Electric Gas Lighting Co., 195 Devonshire Street, Boston, Mass.

**THE MODEL DYNAMO-MOTOR.**

Weight 3/4 pounds. Will light our 6 c. p. lamp, ring bells, explode powder. Output 10 watts. As a motor will develop 1-32 h. p. Wound for voltages 4 or 6 as desired. Other voltages up to 110 to order. Send 2-cent stamp for illustrated catalogue.

**ELBRIDGE ELECTRICAL MANUFACTURING COMPANY,**  
Elbridge, N. Y., U. S. A.

**CALIFORNIA**

**Reliable Information**

about vegetable gardening, soil, grain growing, fruit culture, poultry, climate, water, lands, power, markets, manufacturing facilities, wages. For printed matter and other information write

**California Promotion Committee**  
Representing state commercial organizations, Dept. K. K., 25 New Montgomery St., or Dept. 37, State Board of Trade, SAN FRANCISCO, CALIFORNIA.  
Special low railroad rates during Sept. and Oct.

**ICE YACHT BUILDING.—COMPLETE** details for the construction of Ice Yachts, with many illustrations, are contained in SUPPLEMENT Nos. 624, 1154, 1197 and 1253. Each number gives plans of a different boat. Price 10 cents each. For sale by Munn & Co. and by all newsdealers.

**THE EQUITABLE**

**"STRONGEST IN THE WORLD"**

**J. W. ALEXANDER** PRESIDENT **J. H. HYDE** VICE PRESIDENT

**"GREAT OAKS FROM LITTLE ACORNS GROW"** and great fortunes from little savings grow. For example: Take an Endowment. It gives protection to your family at once--- if you die. Helps provide for your own future--- if you live--- and about 15 cents a day will pay for an Endowment for \$1,000--- 30 dollars a day for \$200,000--- or between amounts in proportion.

Here is the result, in 1902, of Endowment No. 240,125, for \$10,000, taken out twenty years ago:

**Cash.....\$14,934.00**

This is a return of all premiums paid, with \$5,140.00 in addition, to say nothing of the twenty years protection of assurance.

Vacancies in every State for men of energy and character to act as representatives. Apply to **GAGE E. TARBELL, 2nd Vice President**

Send this coupon for particulars of such a policy issued at your age.

**THE EQUITABLE SOCIETY, 120 Broadway, New York.** Dept. No. 29.

Please send me information regarding an Endowment for \$.....if issued at..... years of age.

Name.....

Address.....

**ENORMOUSLY**  
The Largest SALE  
*Egyptian*  
**ARABS**  
Cigarettes  
CORK TIPS OR PLAIN **15<sup>c</sup>**  
SURBRUG COMPANY, Makers

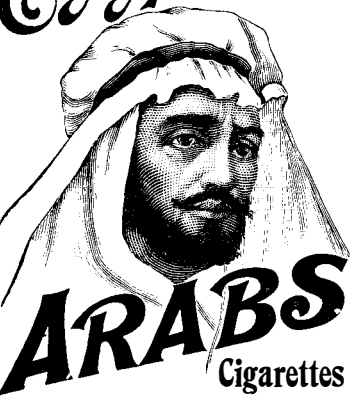

**MADE \$105 THE FIRST MONTH**  
writes FRED BLODGETT, of N. Y. J. L. BARRICK, of La., writes: "Am making \$3.00 to \$5.00 every day I work." MRS. L. M. ANDERSON, of Iowa, writes: "I made \$3.80 to \$6.50 a day." Hundreds doing likewise. So can you. \$5.00 to \$10.00 daily made Plating jewelry, tableware, bicycles, metal goods with gold, silver, nickel, etc. Enormous demand. We teach you FREE. Write—offer free.  
G. GRAY & CO., Plating Works, 2 Miami Bldg., Cincinnati, O.



**"The Sharer"**  
A new foot power that can be applied to all light machinery. A kick starts the machine and an occasional kick keeps it going. Send for our Booklet.  
**SLOTKIN & PRAGLIN,**  
145A Mulberry St., New York.



**Remington**  
**TYPEWRITER**  
The Experience of a Quarter of a Century is **BEHIND IT**  
The Confidence of the Business World is **WITH IT**  
An ever-widening field of usefulness is **BEFORE IT**  
**WYCKOFF, SEAMANS & BENEDICT**  
(Remington Typewriter Company)  
327 Broadway New York

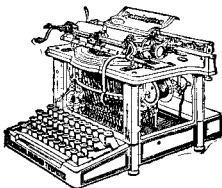

**TUBULAR DRIVING LAMP.**  
IT is the only perfect one.  
IT will not blow or jar out.  
IT gives a clear, white light.  
IT is like an engine head-light.  
IT throws the light straight ahead from 200 to 300 ft.  
IT burns kerosene.  
Send for book (free).  
R. E. DIETZ CO., 60 Laight Street, New York.  
Mention this paper and get special discount.  
—ESTABLISHED 1840.—

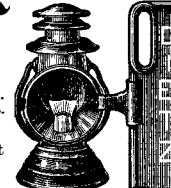

**50 YEARS' EXPERIENCE**  
**PATENTS**  
TRADE MARKS  
DESIGNS  
COPYRIGHTS & C.  
Anyone sending a sketch and description may quickly ascertain our opinion free whether an invention is probably patentable. Communications strictly confidential. Handbook on Patents sent free. Oldest agency for securing patents. Patents taken through Munn & Co. receive special notice, without charge, in the  
**Scientific American.**  
A handsomely illustrated weekly. Largest circulation of any scientific journal. Terms, \$3 a year; four months, \$1. Sold by all newsdealers.  
**MUNN & Co.** 361 Broadway, New York  
Branch Office 625 F St. Washington, D. C.

the Government of South Australia. Adelaide: Printed by C. E. Brostow. 1901. Pp. xv., 81.

"DIFFERENTIAL" '03. Case School of Applied Science. Pp. 178. Square 8vo.

PAINT AND COLOR MIXING. By Arthur Seymour Jennings. London: E. & F. N. Spon, Ltd. New York: Spon & Chamberlain. 1902. Pp. 94.

AMERICAN FOOD AND GAME FISHES. A Popular Account of All the Species Found in America North of the Equator. With Keys for Ready Identification, Life Histories and Methods of Capture. By David Starr Jordan, Ph.D., and Barton Warren Evermann, Ph.D. New York: Doubleday, Page & Co. 1902. Large 8vo. Pp. xlix., 573. Price \$4.

The names of Prof. David Starr Jordan and Prof. Barton Warren Evermann are in themselves a sufficient guarantee of the high character of this book. As it stands, the work comprises what might be termed a popular manual of ichthyology. The publishers have seen to it that the book has appeared in a most admirable dress. The printing is excellent and the illustrations good and clear.

PRINCIPLES OF SANITARY SCIENCE AND THE PUBLIC HEALTH. By William T. Sedgwick, Ph.D. New York: The Macmillan Company. London: Macmillan & Co., Ltd. 1902. Pp. xix., 368. 8vo. Price \$3.

The present volume is the direct outgrowth of a course of lectures on sanitary science and public health given for several years by the author to senior students of the Massachusetts Institute of Technology. The volume deals with the principles rather than the arts of sanitation, and is intended to be no more than an elementary treatise on the subject. It contains, however, some new material and some old material treated from new points of view. The author tells us he has chiefly sought to bring together and to present in a simple and logical form the fundamental scientific principles on which the great practical arts of modern sanitation rest.

LIGHTING BY ACETYLENE. A Treatise for the Practical Lighting Engineer. By Frederick Dye, M.R.I. London: E. & F. N. Spon, Ltd. New York: Spon & Chamberlain. 1902. 12mo. Pp. xii., 188. Price \$2.50.

Mr. Dye has prepared a short book which may be said to contain the most recent information that has been gathered on the subject of acetylene gas. The book's chief merit is its terseness. The illustrations might be improved, although the appearance of the work on the whole is good.

ARCHITEKTONISCHE HOCHBAUMUSTERHEFTE. Sammlung XI., 1. Teil. Moderne Einfamilienhäuser und Villen. Leipzig: Carl Scholtze. 16 plates with description.

This installment of a well-known work deserves the consideration of American architects. The plans and elevations presented are well designed and exhibit architectural ideas, many of which are new in this country.

HANDBOOK FOR RAILWAY ENGINEERS. By H. B. Andrews, C.E. Boston and New York: John Wiley & Sons. 1902. 32mo. Pp. 202. Price \$1.25.

This is another handbook added to the constantly increasing list. It contains the usual geometrical and trigonometrical formulæ, and gives transition curve tables, track construction tables, strength of wooden beams and columns, electrical formulæ and tables, and in general, information that is of service in street railway designs and street railway maintenance.

EXPERIMENTS IN AERODYNAMICS. By S. P. Langley. Second Edition. Washington: Published by the Smithsonian Institution. 1902. Large 4to. Pp. 115.

The value of Prof. Langley's contributions to aerodynamics and the influence which his own experiments in solving the problem of artificial flight have had upon the investigators cannot be over-appreciated. In the handsome volume which lies before us, Prof. Langley has presented with a clearness, conciseness, and, above all, with a modesty that is characteristic of him, the results of the very elaborate investigation which he carried out. We regret that the very limited amount of space at our disposal prevents us from devoting to the work a review commensurate with its importance.

THE NAVIGATOR OR MARINERS' GUIDE. A Handy Reference Work for the Use of Navigators, Yachtsmen and Students of Navigation. Explaining How to Find Latitude and Longitude by Observation and Many Other Useful Calculations and Tables. By Capt. R. M. Pugsley. Published by New Jersey Paint Works. Pp. 152. Price \$2.

This is one of the handiest guides that has ever come to our notice. It gives just the kind of information that the amateur yachtsman wants. We are sorry to see, however, that its pages are liberally interspersed with advertising matter that might well have been relegated to the end of the book.

**PERFORATED METALS**  
FOR ALL USES, MADE AS REQUIRED.  
THE HARRINGTON & KING PERFORATING CO.  
225 N. UNION ST. CHICAGO, ILL. U.S.A.



It is **SELF-CLEANING**  
The Drake Acetylene Burner is not only self-cleaning, but has adjustable alignment and can be re-tipped, making it as good as new. Two styles, costing 30c. & 25c. respectively; \$2.25 & \$3.00 per doz. Send for Cat. Drake Acetylene Apparatus Co., 39 Hathaway St., Cleveland, O.

**Wire Cloth, Wire Lath, Electrically-Welded Wire Fabrics**

and Perforated Metal of all Kinds  
Manufactured by  
**CLINTON WIRE CLOTH COMPANY, CLINTON, MASS.**  
BOSTON NEW YORK CHICAGO SAN FRANCISCO

THE BICYCLE: ITS INFLUENCE IN Health and Disease.—By G. M. Hammond, M.D. A valuable and interesting paper in which the subject is exhaustively treated from the following standpoints: 1. The use of the cycle by persons in health. 2. The use of the cycle by persons diseased. Contained in SCIENTIFIC AMERICAN SUPPLEMENT, No. 1002. Price 10 cents. To be had at this office and from all newsdealers.

**COLD GALVANIZING**  
air and sea water. Our Patent Process is now in use all over the country.  
Co. Herreshoff Boat Building Co., Townsend & Downey, Armour Packing Co. Licenses granted on royalty basis. Sample and custom work done at our factory, 108-110 W. 11th St. Main Office, 348 Broadway. U. S. ELECTRO-GALVANIZING CO.

**YOU WON'T MIND**  
Getting off and fixing the Automobile or lifting it out of a rut, if you have one of our  
**Automobile Jacks**  
Very small, light and powerful. Send for catalogue showing full line including jacks for lifting machinery, etc. Dealers wanted everywhere.  
**WALLACE SUPPLY COMPANY,**  
609 Garden City Block,  
CHICAGO, ILLINOIS.

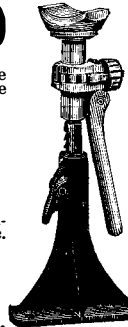

**ELECTRO MOTOR. SIMPLE, HOW TO make.**—By G. M. Hopkins. Description of a small electric motor devised and constructed with a view to assisting amateurs to make a motor which might be driven with advantage by a current derived from a battery, and which would have sufficient power to operate a foot lathe or any machine requiring not over one man power. With 11 figures. Contained in SCIENTIFIC AMERICAN SUPPLEMENT, No. 641. Price 10 cents. To be had at this office and from all newsdealers.

**ELEVATING - CONVEYING POWER TRANSMISSION MACH'Y COAL WASHING MACHINERY**  
Catalogues for Address THE JEFFREY MFG. CO., Columbus, O., U. S. A.

**That Densmore Touch Pleases.**

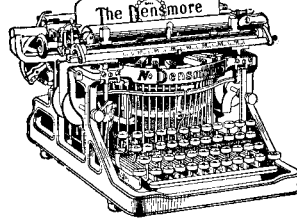
**The Densmore**  

**DENSMORE TYPEWRITER CO., 309 Broadway, New York**  
**BABBITT METALS.—SIX IMPORTANT formulas.** SCIENTIFIC AMERICAN SUPPLEMENT 1123. Price 10 cents. For sale by Munn & Co. and all newsdealers. Send for catalogue.

**PUNCTUREPROOF SELF-HEALING PNEUMATIC BICYCLE TIRES**  
SAVE MONEY AND TROUBLE  
NAILS, TACKS AND GLASS WILL NOT LET THE AIR OUT  
BEURE TIRE IS BRANDED WITH AN ANALOGUE IN RED OTHERS NOT GENUINE  
GUARANTEED NO OTHER TIRE LIKE IT  
PATENTED  
REGULAR PRICE \$10  
NOW \$4.95 PER PAIR  
THIS OFFER IS WITHOUT PARALLEL AND IS LIMITED  
WILL SEND C.O.D. SUBJECT TO EXAMINATION ANYWHERE, NO DEPOSIT REQUIRED  
MADE IN ALL SIZES. CATALOGUE FREE WITH KEY TO THIS ILLUSTRATION & MECHANICAL CONSTRUCTION  
**THE VIM COMPANY, Can. Randolph, Ill. and 11th Ave. CHICAGO**  
Mention SCIENTIFIC AMERICAN.



**\$750**  
**HYDRO-CARBON.**  
20-Mile Speed.  
20 per cent. Grades.  
100-Mile Gasoline Tank.  
300-Mile Water Tank.  
900 lbs. 6 H. P. Actual.  
Write for Catalogue.  
**FRIEDMAN AUTOMOBILE CO.,**  
3 E. Van Buren Street, Chicago, Ill.



**POWER AIR PUMP** FOR STEAM CARRIAGES  
MALTBY  
ADDRESS NO 11 CLINTON ST. BROOKLYN, N.Y.

**CONTROL OF FIRE.—VALUABLE PAPER** on fire extinguishment. SCIENTIFIC AMERICAN SUPPLEMENT 1134. Price 10 cents. For sale by Munn & Co. and all newsdealers.

**Make Sure...**  
that the water you and your family drink is perfectly pure. You can purify any water of its poisonous germs by using  
**THE BERKEFELD FILTER**  
whose system of cylinders holds every particle of solid matter, passing the water through perfectly pure. Easy to clean. A gallon of pure water in four minutes.  
**BERKEFELD FILTER CO., 4 Cedar St., New York**



**Gas Engine IGNITER**  
Complete with spark coil, \$12.00  
The Best Thing on the market. Latest and most improved model.  
Send for Circular.  
**Carlisle & Finch Co., 233 E. Clifton Av., Cincinnati, O.**



**Save all the Spelter** consumed in galvanizing by the hot process by using our Patent Cold Galvanizing Process, as the amount of spelter lost as dross in the hot process if used in our process will give sufficient protection to any kind of work to make it rust-proof even against salt. Our licensees include U. S. Government, The Standard Oil Co., Herreshoff Boat Building Co., Townsend & Downey, Armour Packing Co. Licenses granted on royalty basis. Sample and custom work done at our factory, 108-110 W. 11th St. Main Office, 348 Broadway. U. S. ELECTRO-GALVANIZING CO.

**Note the Graceful Lines**  
upon which the elegant, light and strong  
**BUFFALO STANHOPE**  
is built—just like an ordinary carriage. It is an ideal conveyance for a physician in town or country. It is strengthened at all points but has not the heavy, ugly look of other machines. Has ball bearings throughout, wooden wheels and reaches, hard rubber tires and Collinge style of axles. Price, \$1,800.  
**BUFFALO ELECTRIC CARRIAGE CO., BUFFALO, N. Y.**

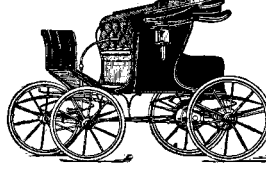

To Owners of Gasoline Engines, Automobiles, Launches, Etc.  
**The Auto-Sparker**  
does away entirely with all starting and running batteries, their annoyance and expense. No belt—no switch—no batteries. Can be attached to any engine now using batteries. Fully guaranteed, write for descriptive catalogue.  
**Motsinger Device Mfg. Co.,**  
14 Main St., Pendleton, Ind.



**Coal Mining Machines**  
ELECTRIC MINE LOCOMOTIVES  
POWER COAL DRILLS  
COAL HANDLING MACHINERY

**DIXON'S GRAPHITOLEO**  
An all around lubricant for Cylinders, Engine Slides, Chains, Gears, Etc. of Automobiles. It is made of pure vaseline and Dixon's No. 635 Graphite. It is equally useful for general use.  
Small Sample Free.  
**JOSEPH DIXON CRUCIBLE CO.**  
Jersey City, N. J.

**15 CENTS GETS THIS \$650.00 AUTOMOBILE**  
  
The OLDSMOBILE—The 20th Century Horseless Carriage.  
Weight, 800 pounds; range of speed, 3 to 20 miles per hour; expense of running, 3/8 cent per mile; price, \$650.00.

Send 15 cents (3 2-c. stamps) for 3 months' trial subscription to  
**"THE BOOK-KEEPER"**  
A handsome magazine for book-keepers, cashiers and business men. It will teach you Accounting, Business Management, Book-keeping, Shorthand, Commercial Law, Short Cuts, Higher, Corporation and Cost Accounting, Banking, Business Pointers, Amusing Arithmetic, Lightning Calculations, etc. \$1.00 a Year.  
**E. H. BEACH, EDITOR**  
Nineteen other valuable prizes in addition to the \$650.00 Automobile will go to Book-Keeper subscribers. Send your subscription to-day.  
**The Book-Keeper Publishing Co., Ltd.**  
16 CAMPAU BLDG., DETROIT, MICH.





A GREAT REPOSITORY OF PRACTICAL AND SCIENTIFIC INFORMATION.

One of the Fullest, Freshest, and Most Valuable Handbooks of the age. Indispensable to Every Practical Man.

SIXTEENTH THOUSAND. PRICE \$2.00. Free of Postage to any Address in the World.

The Techno-Chemical Receipt Book:

Containing Several Thousand Receipts, covering the latest, most important, and most useful Discoveries in Chemical Technology, and their Practical Application in the Arts and the Industries.

Price \$2.00, free of postage to any address in the world. A circular of 32 pages, showing the full Table of Contents of this important Book, sent by mail free of postage to any one in any part of the World who will furnish his address.

HENRY CAREY BAIRD & CO., INDUSTRIAL PUBLISHERS, BOOKSELLERS & IMPORTERS, 810 Walnut St., Philadelphia, Pa., U.S.A.

ELECTRICAL ENGINEERING TAUGHT BY MAIL.

Write for our Free Illustrated Book. "CAN I BECOME AN ELECTRICAL ENGINEER?"

We teach Electrical Engineering, Electric Lighting, Electric Railways, Mechanical Engineering, Steam Engineering, Mechanical Drawing, at your home by mail. Institute endorsed by Thos. A. Edison and others.

LEARN PROOFREADING. If you possess a fair education, why not utilize it at a genteel and uncrowded profession paying \$5 to \$35 weekly? Situations always obtainable. We are the original instructors by mail.

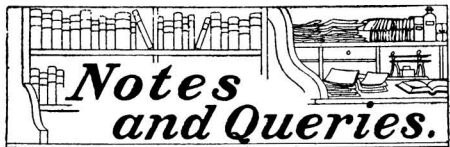

HINTS TO CORRESPONDENTS.

Names and Address must accompany all letters or no attention will be paid thereto. This is for our information and not for publication. References to former articles or answers should give date of paper and page or number of question.

(8700) G. L. asks: I have an induction coil guaranteed to give a 1-inch spark. What amount of current will be required to make the 1-inch spark, and what number of 1900 dry cells or Bunsen's batteries will operate it?

(8701) A. C. asks: A farmer in plowing around a square field, having plowed a strip ten rods wide, finds that he has one-fourth of his field plowed. How many acres in the field? A. The problem you send is not an arithmetical problem, but requires for its solution an equation of the second degree in algebra.

(8702) J. H. B. writes: I notice in your columns of August 2 the statement that "an aluminium ball and a lead ball of the same size would fall, in still air, at the same speed."

C. E. D. also writes: In a recent issue G. M. T asks (query 8650) concerning the falling of two spheres of same size but different weight, and you reply that they will fall in a vacuum with the same velocity, likewise the same in air.

C. E. D. also writes: In a recent issue G. M. T asks (query 8650) concerning the falling of two spheres of same size but different weight, and you reply that they will fall in a vacuum with the same velocity, likewise the same in air.

C. E. D. also writes: In a recent issue G. M. T asks (query 8650) concerning the falling of two spheres of same size but different weight, and you reply that they will fall in a vacuum with the same velocity, likewise the same in air.

C. E. D. also writes: In a recent issue G. M. T asks (query 8650) concerning the falling of two spheres of same size but different weight, and you reply that they will fall in a vacuum with the same velocity, likewise the same in air.

C. E. D. also writes: In a recent issue G. M. T asks (query 8650) concerning the falling of two spheres of same size but different weight, and you reply that they will fall in a vacuum with the same velocity, likewise the same in air.

C. E. D. also writes: In a recent issue G. M. T asks (query 8650) concerning the falling of two spheres of same size but different weight, and you reply that they will fall in a vacuum with the same velocity, likewise the same in air.

C. E. D. also writes: In a recent issue G. M. T asks (query 8650) concerning the falling of two spheres of same size but different weight, and you reply that they will fall in a vacuum with the same velocity, likewise the same in air.

C. E. D. also writes: In a recent issue G. M. T asks (query 8650) concerning the falling of two spheres of same size but different weight, and you reply that they will fall in a vacuum with the same velocity, likewise the same in air.

C. E. D. also writes: In a recent issue G. M. T asks (query 8650) concerning the falling of two spheres of same size but different weight, and you reply that they will fall in a vacuum with the same velocity, likewise the same in air.

C. E. D. also writes: In a recent issue G. M. T asks (query 8650) concerning the falling of two spheres of same size but different weight, and you reply that they will fall in a vacuum with the same velocity, likewise the same in air.

C. E. D. also writes: In a recent issue G. M. T asks (query 8650) concerning the falling of two spheres of same size but different weight, and you reply that they will fall in a vacuum with the same velocity, likewise the same in air.

C. E. D. also writes: In a recent issue G. M. T asks (query 8650) concerning the falling of two spheres of same size but different weight, and you reply that they will fall in a vacuum with the same velocity, likewise the same in air.

C. E. D. also writes: In a recent issue G. M. T asks (query 8650) concerning the falling of two spheres of same size but different weight, and you reply that they will fall in a vacuum with the same velocity, likewise the same in air.

C. E. D. also writes: In a recent issue G. M. T asks (query 8650) concerning the falling of two spheres of same size but different weight, and you reply that they will fall in a vacuum with the same velocity, likewise the same in air.

C. E. D. also writes: In a recent issue G. M. T asks (query 8650) concerning the falling of two spheres of same size but different weight, and you reply that they will fall in a vacuum with the same velocity, likewise the same in air.

C. E. D. also writes: In a recent issue G. M. T asks (query 8650) concerning the falling of two spheres of same size but different weight, and you reply that they will fall in a vacuum with the same velocity, likewise the same in air.

C. E. D. also writes: In a recent issue G. M. T asks (query 8650) concerning the falling of two spheres of same size but different weight, and you reply that they will fall in a vacuum with the same velocity, likewise the same in air.

C. E. D. also writes: In a recent issue G. M. T asks (query 8650) concerning the falling of two spheres of same size but different weight, and you reply that they will fall in a vacuum with the same velocity, likewise the same in air.

C. E. D. also writes: In a recent issue G. M. T asks (query 8650) concerning the falling of two spheres of same size but different weight, and you reply that they will fall in a vacuum with the same velocity, likewise the same in air.

C. E. D. also writes: In a recent issue G. M. T asks (query 8650) concerning the falling of two spheres of same size but different weight, and you reply that they will fall in a vacuum with the same velocity, likewise the same in air.

A FREE EDUCATION



How you can become an ELECTRICIAN, JOURNALIST, BOOKKEEPER, STENOGRAPHER, ARTIST, PROOFREADER, ADVERTISEMENT WRITER.

The management of the Correspondence Institute of America have decided to award a limited number of Free Tuition contracts in the following courses of home study:

ILLUSTRATING, CARICATURE, ADVERTISEMENT-WRITING and MANAGEMENT, JOURNALISM, PROOFREADING, BOOKKEEPING, STENOGRAPHY, and PRACTICAL ELECTRICITY,

to well-recommended, ambitious persons. From such persons who are awarded Free Tuition contracts no tuition fee will be required until the institution has educated them and secured for them a position. We advertise all over the country for positions for our students.

Write for application blank, and mention the course which interests you. CORRESPONDENCE INSTITUTE OF AMERICA, Box 689, Scranton, Pa.

POSITIONS SECURED

ENGINEER'S LICENSE

Mechanics, Engineers, Firemen, Electricians, Etc. 40-page pamphlet containing questions asked by Examining Board of Engineers. Also send for 95-page catalogue free of charge.

GEORGE A. ZELLER, PUBLISHER, Room 600, 18 S. Fourth St., St. Louis, Mo.

USE NO MATCHES!!

Light your gas with a PUSH BUTTON! SIMPLE, SAFE and ECONOMICAL. Can be put in by anyone.

To learn how, send for book, "ELECTRIC GAS LIGHTING." Copies mailed for 50c.

SPON & CHAMBERLAIN, Publishers of Electrical Books, 128 Liberty St., New York, U.S.A.

DIVIDENDS

Risk a postal. Send us your name for prospectus of the Rayo Mining and Developing Co. of California. Every dollar invested in these shares will return you regular, handsome, dividends.

ROANOKE INVESTMENT CO., 525 Marquette Building, Chicago.

A Handy Book To Have

Montgomery & Co.'s Tool Catalogue. It is illustrated throughout and describes and prices Tools. 704 pages, 6 1/2 x 4 1/2 ins. The latest edition, with discount sheet by mail for 25 cents.

MONTGOMERY & CO., 105 Fulton St., New York City.

CARS

FOR EVERY PURPOSE. Rails, Portable Track, Switches, Etc. AND ALL ACCESSORIES ALWAYS IN STOCK.

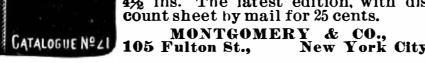

ARTHUR KOPPEL, Dept. P, 66-68 Broad St., New York. Write for Catalogue No. 30.

THE SPAULDING GASOLINE RUNABOUT



PRICE \$700. Light, strong, safe and durable, above all easy to operate. Has no complicated devices. About everything imaginable has been said in commendation of its style and beauty. Get our catalog.

SPAULDING AUTOMOBILE & MOTOR CO., Buffalo, N. Y.

YOU ONLY RISK \$1



In order to keep things moving during the hot weather, on receipt of \$1.00, I will ship to any station in the United States A 400-LB. WILLARD STEEL RANGE. Guaranteed in every respect. It has six 8-inch lids; oven, 17x12x21. Top cooking surface, 30x36. Large warming cabinet. 15-gallon reservoir. Duplex grates, burn wood or coal. Lined throughout with asbestos. On arrival, if you are perfectly satisfied, pay the agent \$14.00 and freight. You only risk \$1.00 to find out what can be saved by being wide-awake. FOR FREE DESCRIPTIVE CIRCULAR AND TESTIMONIALS, WRITE

WM. G. WILLARD, Dept. 14, 619-621 N. 4th St., ST. LOUIS, MO.

2d HAND GAS and GASOLINE ENGINES

Save 30 to 50 per cent. Second hand engines in stock from 1 to 30 h. p., all makes, all prices. Suitable for every power purpose. We can meet your wants. All engines in thorough order and guaranteed. Write for illustrated lists and state your wants.

Callison Motor Co., 271 West St., New York.

"THIS BEATS NEW JERSEY."

Charters procured under South Dakota laws for a few dollars. Write for Corporation laws, blanks, by-laws and forms to PHILIP LAWRENCE, late Ass't Secretary of State, Huron, Beadle Co., South Dakota.

SMALL SPRINGS OF EVERY DESCRIPTION

FLAT OR ROUND WIRE, STEEL OR BRASS. THE WALLACE BARNES CO. 18 MAIN ST. BRISTOL, CONN.

MODELS, DIES AND PUNCHES

Special Machinery, Wood and Metal Patterns, Stampings, etc. Hoelt & Moore, 85 and 87 Fifth Ave., Chicago.

FREE

Catalogue of Architectural, Scientific and Technical Books. Prospectus for 1902, for "Architects' and Builders' Magazine," monthly \$2 a year.

WM. T. COMSTOCK, Pub., 23 Warren St., New York.

MODELS & GEARS

CATALOGUES FREE. UNION MODEL WORKS, 193 CLARK CHICAGO.

MATCH Factory Machinery

W. E. WILLIAMS, Mfr., 217 South Clinton St., Chicago, U. S. A.

ICE MACHINES, Corliss Engines, Brewers' and Bottlers' Machinery

THE VILBER MFG. CO., 899 Clinton Street, Milwaukee Wis.

SPECIAL MANUFACTURING, SPEC. MACHINERY, MODELS

EXPERIMENTAL WORK, DIES AND STAMPING. PROMPT GLOBE MACH. & STAMPING CO. 970 HAMILTON ST. CLEVELAND, O.

Cement Books

How to Use Portland Cement, 50c; Monier, Cement & Steel, 50c. Cement and Engineering News, 162 La Salle St., Chicago

ELECTRIC KNOWLEDGE

Send 10 cents and we will mail any of these books: "How to Wire Houses for Electric Bells," "Burglar Alarms," "Telephones," "Electric Gas Lighting." Prices and diagrams in each. Books on incandescent lighting, 25 cents.

GENTEL & MILLER, 1503 Columbia Ave., Philadelphia

BERRYMAN Heaters

BENJ. F. KELLEY & SON, 91 Liberty St., New York. Manufacturers of the (KELLEY PATENT) Improved Berryman water tube Feed Water Heater and Purifier. A thoroughly up-to-date, reliable and efficient heater. Made to stand the highest pressure and so constructed as to be utterly indestructible by the heaviest boiler pressure it is possible to carry. Write for catalogue.

MODELS & EXPERIMENTAL WORK

Inventions developed. Special Machinery. E. V. BAILLARD, Fox Bldg., Franklin Square, New York.

MODEL and EXPERIMENTAL WORK

Mechanical and Electrical Engineer. Drawings and Designs for Special Work. CHAS. W. GRAHAM, 106 E. 28th Street, New York.

EXPERT MODEL MAKERS

Models, Patterns, Dies & Novelties. Experimental work. WAGNER MFG. CO., 9 Mohawk St., Chicago, Ill.

I PRINT MY OWN CARDS

Circulars, newspaper, Press, \$5. Larger size, \$18.00. Money saver. Big profits printing for others. Type setting easy, rules sent. Write for catalog, presses, type, paper, etc., to factory, The Press Co., Meriden, Conn.

AGENTS WANTED

In every county in the State to sell Transparent Handle Pocket Knives. Good commissions paid. From \$75 to \$300 a month easily made. Write for terms. Novelty Cutlery Co., 2 Bar St., Canton, O.

FOR SMALL SHOPS, FARM, PUMPING, ELECTRIC

WATER LAUNCHES & COMPLETE AUTOMATIC PLANTS GUARANTEED. MILWAUKEE POWER PLANT CO. P.O. BOX 762, MILWAUKEE, WIS.

Our Steam Carriages Excel in Running Qualities



Ease of Handling, Reliability, Strength and Finish. Impossible to tell all about them here. Write us for catalogue. Inquiries cheerfully answered.

THE CONRAD MOTOR CARRIAGE COMPANY, 1417 Niagara St., Buffalo, N. Y.

Advertisement for Consolidated Schools, featuring an illustration of a school building and a flag. Text: "A Secure Position is yours, if you are properly trained. What manufacturers and business men are calling for every day are trained men. Our booklet 'How to Earn More' contains interesting facts and helpful information. Send for a copy. IT'S FREE. Our courses for home study include Engineering, Illustrating, Architecture, Decorating, Mining, Journalism, Metallurgy, Bookkeeping, Art, Stenography, and English Branches. SEND FOR CATALOGUE 6. THE CONSOLIDATED SCHOOLS, 156 Fifth Ave., New York."

Advertisement for N. Y. School of Caricature, featuring a caricature of a man's face. Text: "Want to draw? If you have a liking or a natural Talent for Drawing, cut this out mail with your address and receive our FREE sample Lesson Circular with terms, and twenty Portraits of well-known artists and illustrators. N. Y. SCHOOL OF CARICATURE, Studio 85 World Building, New York City."

Advertisement for The Hapgood Bureau, featuring a circular logo. Text: "ARE YOU TRAVELING IN A CIRCLE? As Employee or Employer, are your business connections satisfactory? We find positions and furnish Capable High-grade Executive and Technical Men at short notice. Write for our booklet. THE HAPGOOD BUREAU, 257 Broadway, NEW YORK."

Advertisement for Munroe, Hall & Hopkins, Chemists, Electrochemists, and Engineers. Text: "MUNROE, HALL & HOPKINS, CHEMISTS, ELECTROCHEMISTS, and ENGINEERS. Room 725, BOND BUILDING, WASHINGTON, D. C. Inventions and Processes Perfected. Plants and Equipments Designed. Expert Opinion in Patent Causes. Measurements, Tests, and Efficiency Determinations. Laboratory Investigations carried on and Reports rendered. Analyses of every description made. CHARLES E. MUNROE, Ph. D., F. C. S. N. MONROE HOPKINS, Ph. D., A. I. E. E. CLARENCE HALL, M. A. C. S. Long Distance Telephone No. Main 2583-y."

Advertisement for Douglas, Lacey & Co., Bankers & Brokers, Fiscal Agents. Text: "OIL--SMELTER--MINES Dividend-Paying Mining, Oil and Smelter Stocks, Listed and Unlisted, our Specialty. DOUGLAS, LACEY & CO. Bankers & Brokers, Fiscal Agents, Members N. Y. Consolidated Stock Exchange. 66 BROADWAY & 17 NEW ST., NEW YORK. Booklets giving our successful plan for realizing the large interest and profits of legitimate mining, oil and smelter investments, sub. blanks, full particulars, etc., sent free on application."

**THOROUGH INSPECTIONS**  
 AND INSURANCE AGAINST LOSS OR DAMAGE TO PROPERTY AND LOSS OF LIFE AND INJURY TO PERSONS CAUSED BY STEAM-BOILER-EXPLOSIONS  
 HARTFORD STEAM BOILER INSPECTION AND INSURANCE CO. CONN.  
 J. M. ALLEN, PRESIDENT W. B. FRANKLIN, VICE PRESIDENT  
 J. W. ALLEN, SECRETARY R. B. BRANFORD, TREAS.  
 L. F. MIDDLEBROOK, ASST. SECY.

# THE WINTON "PUP"

During the recent race meetings this wonderful car showed itself in a class by itself. It contains a 70 H. P. motor, which is to be the standard in the coming season's WINTON TOURING CAR.

**CHARTER ENGINE USED ANY PLACE FOR ANY PURPOSE**  
 Stationaries, Portables, Sawing Outfits, Hoisters, Engines and Pumps.  
 Fuel—Gasoline, Gas, Distillate.  
 Send for Illustrated Catalogue and Testimonials, and State Your Power Needs.  
 CHARTER GAS ENGINE CO., Box 148, STERLING, ILL.

**BARGAIN IN MOTORS**  
 Five H. P. Duplex Motors for \$115  
 Having contracted for a larger number of these popular air-cooled motors than we are able to use this season, and as we wish to turn them into ready money, we offer a few at a price previously unheard of. Write immediately for information to THE LOOMIS AUTOMOBILE CO., WESTFIELD, MASS.

**JESSOP'S STEEL** THE VERY BEST FOR TOOLS, SAWS ETC.  
 Wm. JESSOP & SONS L<sup>td</sup> 91 JOHN ST. NEW YORK

Analyze the trade-mark—the petals of flower spell the name

**COSMOS PICTURES**  
 A Feast for Picture Lovers and Collectors

Sold in stores or sent by mail, ten pictures of standard size, or four of the larger size, for twenty-five cents.

Special Offer to Readers of Scientific American: To anyone not familiar with these pictures we will send for twenty-five cents, five of our most popular subjects of standard size, with two of the larger size, and a complete catalog containing a thousand illustrations, if you will mention the Scientific American.

Catalog 30 may be ordered separately for two 2-cent stamps.

**COSMOS PICTURES COMPANY**  
 296 BROADWAY, NEW YORK

**PARALLEL CH-BESLY & CO.**  
 CLAMPS ALL ANGLES (Chicago) ALL SIDES—U.S.A.

## The Typewriter Exchange

1 1/2 Barclay St., NEW YORK  
 124 La Salle St., CHICAGO  
 38 Bromfield St., BOSTON  
 817 Wyandotte St., KANSAS CITY, MO.  
 209 North 9th St., ST. LOUIS, MO.  
 536 California St., SAN FRANCISCO, CAL.  
 We will save you from 10 to 50% on Typewriters of all makes. Send for Catalogue.

## NEW ENGLAND WATCHES

have a world-wide reputation gained by results as accurate timekeepers. We make all sizes and styles. We sell only complete watches. Catalogs sent on request.

**THE NEW ENGLAND WATCH CO.**  
 37 & 39 Maiden Lane New York  
 131 Wabash Ave., Chicago.  
 Claus Spreckels Building, San Francisco.

**DICKERMAN'S DURABLE DESKS**  
 AMERICAN DESK & STOOL CO., 33 Howard St., just East of 43d St., New York City.

**RIVETT LATHE**  
 No up-to-date manufacturer can afford to do without it.  
**GOLD MEDAL AT THE PAN-AMERICAN EXPOSITION.**  
 Send for Catalogue.  
 Fanett Watch Tool Company, BRIGHTON, BOSTON, MASS., U. S. A.

# Waltham Watches.

"From North to South, from East to West."

"The Perfected American Watch," an illustrated book of interesting information about watches, will be sent free upon request.

American Waltham Watch Company, Waltham, Mass.

## Orient Motor Cycle.



PRICE \$250.00  
 Fitted with the New Orient 3 H. P. Motor. Speed over 40 Miles per hour. The Most Powerful Motor Bicycle in the World. Write for Particulars. Agents Wanted.  
**WALTHAM MFG. CO., Waltham, Mass.**

## The Haynes-Apperson Automobile

The Most Practical Automobile in the World.  
**LONG ISLAND ENDURANCE CONTEST.**  
 WE WON both years; the only make to do so.  
**EVERY TYPE WE MAKE HAS WON THE BLUE RIBBON.**  
 Surrey, 9 h. p., (four passengers), \$1,800.  
 Phaeton, 9 h. p., (two passengers), \$1,500.  
 Runabout, 6 h. p., (two passengers), \$1,200.  
 We have never entered a contest that we have not won. Look up our records. Get our catalogues.  
**THE HAYNES-APPERSON COMPANY, KOKOMO, IND.**  
 (The oldest makers of gasoline cars in America. The details of a motor car cannot be perfected in one season.)

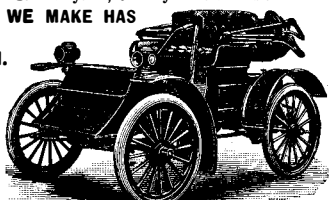

## Columbia Automobiles

Electric & Gasoline  
 RUNABOUTS, SURREYS, TONNEAUS  
 DELIVERY WAGONS, VICTORIAS, CABRIOLETS,  
 BROUGHAMS, TRUCKS, AMBULANCES,  
 POLICE PATROL WAGONS.  
 Write for our latest Catalogue illustrating and describing seventeen different Columbia Models.  
**ELECTRIC VEHICLE CO., Hartford, Conn.**  
 New York, 100 Broadway. Boston, 43 Columbus Ave. Chicago, 1421 Michigan Ave.

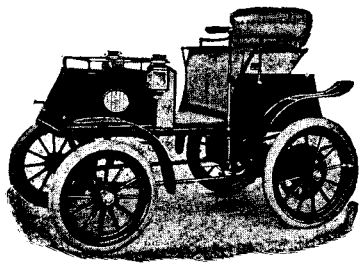

## FOR MEN OF BRAINS

# Cortez CIGARS

—MADE AT KEY WEST—

These Cigars are manufactured under the most favorable climatic conditions and from the mildest blends of Havana tobacco. If we had to pay the imported cigar tax our brands would cost double the money. Send for booklet and particulars.

**CORTEZ CIGAR CO., KEY WEST.**

## COLD GALVANIZING. AMERICAN PROCESS. NO ROYALTIES.

SAMPLES AND INFORMATION ON APPLICATION.  
**NICKEL AND Electro-Plating Apparatus and Material.**  
 THE Hanson & Van Winkle Co., Newark, N. J., 136 Liberty St., N. Y. 30 & 32 S. Canal St. Chicago.

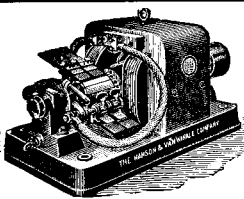

SEND YOUR BUSINESS CARD FOR CATALOGUE.



## Dress for Comfort

In work or play the "President" is the easiest suspender a man can wear. Constructed on a scientific, comfort-giving principle, it answers every bend and twist of the body. The

# PRESIDENT SUSPENDER

is guaranteed if "President" is on buckles. Trimmings cannot rust. Made heavy or light—also for youths. 50 cts. everywhere, or mailed postpaid. Say light or dark—wide or narrow. Holiday goods in individual gift boxes, now ready. President playing cards, instructive, entertaining, unique, 25 cts.  
**C. A. EDGARTON MFG. COMPANY,**  
 Box 222 E, Shirley, Mass.

**Scales** All varieties at lowest prices. Best Railroad Track and Wagon or Stock Scales made. Also 100 useful articles, including Saws, Sewing Machines, Bicycles, Tools, etc. Save Money. Lists Free. **CHICAGO SCALE CO., Chicago, Ill.**

## MAGIC LANTERNS

**STEREOPTICONS and VIEWS**  
 for Public Exhibitions, Church Entertainments, for illustrating sermons. Many sizes, all prices. Chance for men with little capital to make money. 260 page catalogue free.  
**McALLISTER, Mfg. Optician, 49 Nassau Street, N. Y.**

## CRACKS IN FLOORS...

are permanently and easily filled with Grippin's Wood Crack and Crevice Filler and patent applicator. Before finishing your floors, whether old or new, write for our booklet on Grippin's famous floor specialties, to  
**GRIPPIN MFG. CO., Dept. C., Newark, N. Y.**

## GASOLINE MOTOR PLANT FOR SALE

AT A REASONABLE PRICE.  
 A completely equipped plant for making the finest grade of gasoline motors. All modern tools and machinery.  
**THE HOLLAND AUTO. CO.,**  
 Van Winkle Ave., Jersey City, N. J.

# Torrey's Best

stamped on a strop means that Torrey Stropps are superior to all others for sharpening qualities. No other stropps are as good as

## TORREY STROPPS

Torrey Cushion Stropps, 50c, 75c, \$1.00, \$1.50 and \$2.00. Torrey Swing Stropps, 50c, 75c, \$1.00 and \$1.50. Sent postpaid if your dealer cannot supply you. Send for trial package of Torrey Strop Dressing; good for any strop.  
**SPECIAL SCISSORS OFFER.**  
 Send 25 cents and the address of a man who shaves, and we will send you a pair of Torrey's Best 75-cent Scissors—large, medium or small. Money refunded if not satisfactory.  
**J. E. TORREY & CO.,**  
 P.O. Box 84, Worcester, Mass.

## IT WILL PAY YOU TO KNOW US.

We build patterns for all kinds of machinery and architecture at reasonable rates. We have constructed a line of machinery for the accurate shaping and spacing of the teeth of all kinds of gear—rack and ratchet patterns. Superior to hand work and much cheaper. Booklet free.  
**BUFFALO GEAR & PATTERN WORKS, Buffalo, N. Y.**

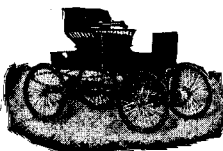

## Crestmobile

PRICE \$600  
 Speed and Comfort  
**CREST MFG. CO.,**  
 Cambridge, Mass.

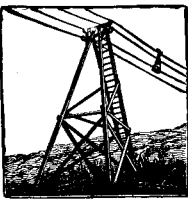

## PATENT AERIAL WIRE ROPE TRAMWAY

For Transportation of Ore, Coal, Dirt, Timber, etc.  
 Perfect Grip Clip. Absolutely Safe. Loads Automatically. Unloads Automatically. Operated by One Man. Cost of Maintenance Low. Capacity Largest Obtainable.  
**A. LESCHEN & SONS ROPE COMPANY.** Home Office, 920-922 North Main Street, St. Louis, Mo.  
 Branch Offices: 32 Centre Street, New York City, N. Y. 137 E. Lake Street, Chicago, Ill. 85 Fremont Street, San Francisco, Cal.

